



## Garden & Storage

---

Canopy For Garden Shed Lagos  
(RF2237034 / RF2238216)

Suitable for:  
300 - (RF2237029 / RF2238212)



**Instruction manual**



**Montage handleiding**



**Montageanleitung**



**Manuel d'instruction**

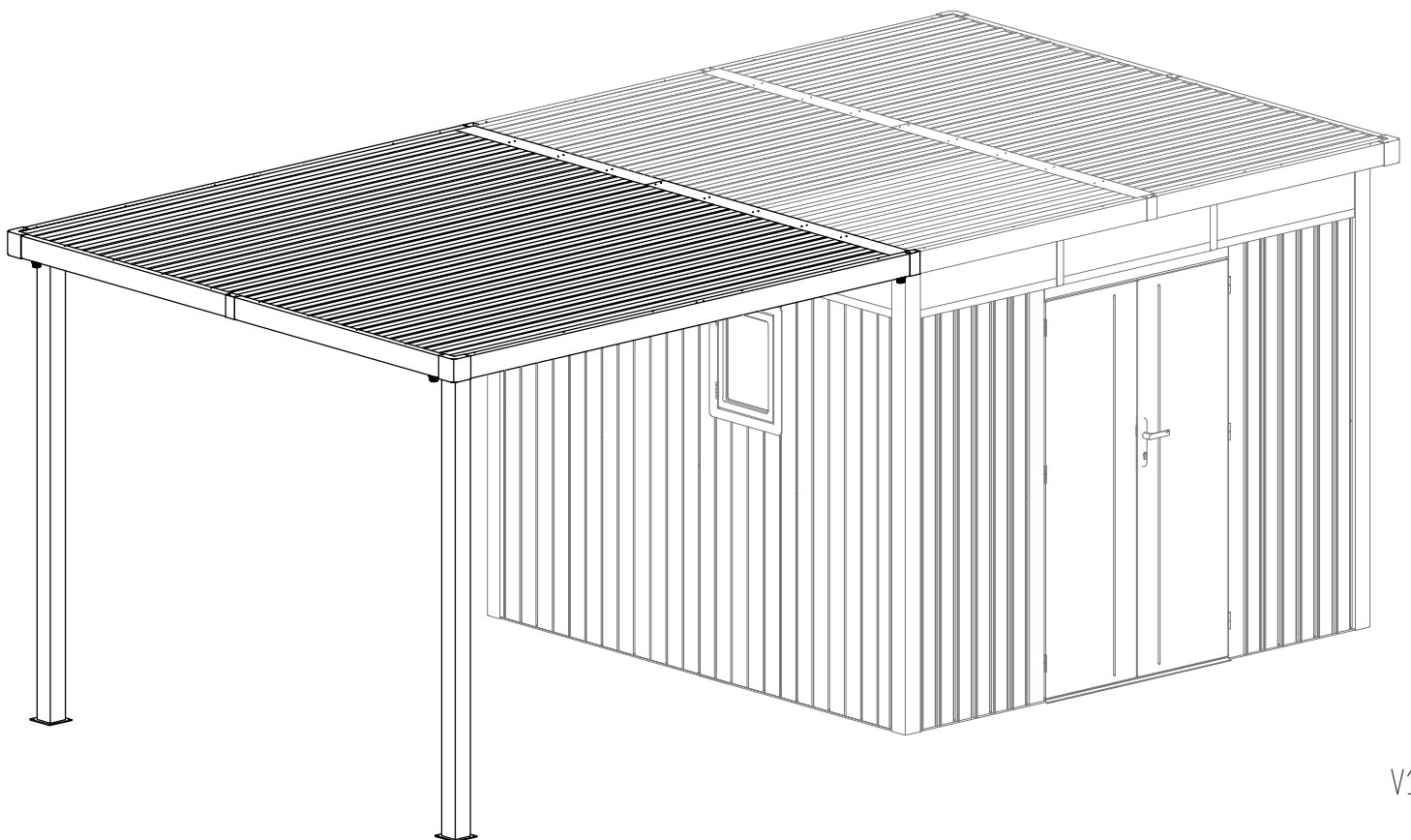



## Important Information:

### Pre-Assembly Checklist:

Before starting the assembly, please ensure:

- All listed parts are supplied and undamaged.
- Report any missing parts within 14 days of delivery AND before assembly!
- For reporting missing parts, please contact your point of sale (store or website) where your product was purchased.
- Do not discard the packaging without confirming the proper functioning of the product.

### Product Assembly Guidelines:

- Avoid rainy days, prevailing winds, and overhanging trees. Check the surrounding area for any possible obstructions near or within the product placement.
- Ensure at least 1 extra persons are present during assembly. This will help speed up assembly time.
- Keep children away from the assembly area.
- Exercise caution to avoid the risk of pinching.
- Follow all assembly steps meticulously and verify the structure's level on all sides.
- We recommend you re-check tightness of all relevant fasteners and the level of the complete structure before starting assembly of accessories
- Properly anchor the main structure to the ground or foundation before adding accessories.
- Please ensure that you retain the instruction manual and do not throw it away after assembly.
- The user is liable for any damages or injuries caused due to incorrect or improper installation.

### **Warranty Information:**

The warranty applies to manufacturers defects and covers the replacement of spare parts or the provided product, no refunds will be issued. The manufacturers warranty does not cover:

- Normal wear and tear.
- Loss or breakage during unpacking or installation.
- Lack of care, neglect, vandalism, impact with foreign objects, contact with abrasive materials, aesthetics, incorrect assembly or disassembly, rebuilding, or relocation and including and not limited to all points mentioned in the above weather conditions paragraph.
- Force majeure events like hail, high winds, storms, snow, floods, lightning, etc.
- Modifying the product voids the warranty; user-tampered products are not covered.

All warranty claims must be directed to the point of sale (store or website) where your product was purchased.

Please ensure you send the following details:

- Proof of purchase
- A detailed description of the problem.
- Clear and complete pictures of the problem.

Your claim will then be assessed accordingly.

### **Maintenance Recommendations:**

To ensure longevity and aesthetic appeal, regular maintenance is essential.

We recommend:

- Cleaning with fresh water using a soft sponge or cloth once or twice a year (or more).
- Avoid using detergents or abrasive materials during cleaning.
- Regularly checking the tightness of screws (at least once a year).
- Applying WD-40 (or similar product) to fasteners to clean and increase surface rust resistance
- Ensuring unobstructed water flow in gutters (clearing leaves, branches, etc.).

## Belangrijke informatie:

### Montage voorbereiding/ Controlelijst:

- Voordat u met de montage begint, zorg ervoor dat:
- Alle vermelde onderdelen zijn geleverd en onbeschadigd zijn.
- Meld ontbrekende onderdelen binnen 14 dagen na levering EN voor de montage!
- Voor het melden van ontbrekende onderdelen, neem contact op met het verkooppunt (winkel of website) waar uw product is gekocht.
- Gooi de verpakking niet weg zonder de goede werking van het product te bevestigen.

### Product Assemblage Richtlijnen:

- Vermijd regenachtige dagen, overheersende winden en overhangende bomen. Controleer de omliggende omgeving op mogelijke obstakels in de buurt van of binnen de plaatsing van het product.
- Zorg ervoor dat er minstens 1 extra persoon aanwezig is tijdens de montage, dit bevordert een snellere montage.
- Houd kinderen uit de buurt van het montagegebied.
- Wees voorzichtig om het risico op beknelling te vermijden.
- Volg alle montageschappen nauwgezet en controleer meermalig het waterpas niveau en hoeken van het product.
- Wij raden u aan de stevigheid van alle relevante bevestigingsmiddelen en het niveau van de hoofdconstructie opnieuw te controleren voordat u begint met de montage van accessoires.
- Veranker de hoofdconstructie op de juiste manier in de grond of fundering voordat u accessoires toevoegt.
- Zorg ervoor dat u de instructiehandleiding bewaart en deze niet weggooit na de montage.
- De gebruiker is aansprakelijk voor eventuele schade of letsel veroorzaakt door onjuiste of onjuiste installatie.

## **Garantie-informatie:**

De fabrieksgarantie geldt voor fabrieksdefecten en omvangt de vervanging van reserveonderdelen of het geleverde product, er worden geen restituties verstrekt. De fabrieksgarantie dekt niet:

- Normale slijtage.
- Verlies of breuk tijdens het uitpakken of installeren.
- Gebrek aan zorg, verwaarlozing, vandalisme, impact met externe objecten, contact met schurende materialen, esthetiek, onjuiste montage of demontage, herbouw of verplaatsing en inclusief maar niet beperkt tot alle punten genoemd in de bovenstaande alinea over weersomstandigheden.
- Overmachtgebeurtenissen zoals hagel, harde wind, stormen, sneeuw, overstromingen, bliksem, etc.
- Het wijzigen van het product maakt de garantie ongeldig; door de gebruiker gemanipuleerde producten vallen niet onder de dekking.

Alle garantieclaims moeten worden gericht aan het verkooppunt (winkel of website) waar uw product is gekocht.

Zorg ervoor dat u de volgende gegevens meestuur:

- Aankoopbewijs
- Een gedetailleerde beschrijving van het probleem.
- Duidelijke en volledige foto's van het probleem.

Uw claim wordt dan zorgvuldig beoordeeld.

## **Onderhoudsadviezen:**

Om de levensduur en esthetische aantrekkingskracht te waarborgen, is regelmatig onderhoud essentieel.

Wij raden aan:

- Schoon te maken met schoon water, met een zachte spons of doek een- of tweemaal per jaar (of vaker).
- Vermijd het gebruik van reinigingsmiddelen of schurende materialen tijdens het reinigen.
- Controleer regelmatig de stevigheid van schroeven (minstens eenmaal per jaar).
- Het aanbrengen van WD-40 (of een vergelijkbaar product) op bevestigingsmiddelen om ze schoon te maken en de oppervlakteroestbestendigheid te verhogen.
- Zorg voor een onbelemmerde waterafvoer in dakgoten (bladeren, takken, enz. verwijderen).

## Wichtige Informationen:

### Vor-Montage-Checkliste:

- Bevor Sie mit der Montage beginnen, stellen Sie bitte sicher:
- Alle aufgeführten Teile sind vorhanden und unbeschädigt.
- Melden Sie fehlende Teile innerhalb von 14 Tagen nach Lieferung UND vor der Montage!
- Für die Meldung fehlender Teile wenden Sie sich bitte an den Verkaufspunkt (Geschäft oder Website), an dem Ihr Produkt gekauft wurde.
- Werfen Sie die Verpackung nicht weg, ohne die ordnungsgemäße Funktion des Produkts zu bestätigen.

### Montagerichtlinien für das Produkt:

- Vermeiden Sie Regentage, vorherrschende Winde und überhängende Bäume. Überprüfen Sie die Umgebung auf mögliche Hindernisse in der Nähe oder innerhalb der Produktplatzierung.
- Stellen Sie sicher, dass während der Installation mindestens eine zusätzliche Person anwesend ist, dies beschleunigt die Installation.
- Halten Sie Kinder vom Montagebereich fern.
- Achten Sie darauf, Quetschgefahr zu vermeiden.
- Befolgen Sie alle Installationsschritte sorgfältig und überprüfen Sie mehrmals die Wasserwaage und die Winkel des Produkts.
- Wir empfehlen Ihnen, den festen Sitz aller relevanten Befestigungselemente und die Höhe der Haupts Konstruktio n erneut zu überprüfen, bevor Sie mit der Installation von Zubehörteilen beginnen.
- Verankern Sie die Haupts Konstruktio n ordnungsgemäß im Boden oder Fundament, bevor Sie Zubehör hinzufügen.
- Bewahren Sie die Bedienungsanleitung unbedingt auf und werfen Sie sie nach der Installation nicht weg.
- Der Benutzer haftet für Schäden oder Verletzungen, die durch eine fehlerhafte oder unsachgemäße Installation verursacht werden.

## **Garantieinformationen:**

Die Herstellergarantie gilt für Fabrikmängel und umfasst den Ersatz von Ersatzteilen oder der gelieferten Produkt ab, keine Rückerstattungen werden gewährt. Die Herstellergarantie deckt nicht:

- Normale Abnutzung.
- Verlust oder Bruch während des Auspackens oder der Installation.
- Mangelnde Pflege, Vernachlässigung, Vandalismus, Aufprall mit Fremdkörpern, Kontakt mit abrasiven Materialien, ästhetische Probleme, falsche Montage oder Demontage, Wiederaufbau oder Verschiebung und einschließlich, jedoch nicht beschränkt auf alle Punkte, die im obigen Abschnitt zu den Wetterbedingungen genannt werden.
- Höhere Gewalt wie Hagel, starke Winde, Stürme, Schnee, Überschwemmungen, Blitz usw.
- Eine Änderung des Produkts führt zum Erlöschen der Garantie; vom Benutzer manipulierte Produkte sind nicht abgedeckt.

Alle Garantieansprüche müssen an den Verkaufspunkt (Geschäft oder Website) gerichtet werden, wo Ihr Produkt gekauft wurde. Stellen Sie sicher, dass Sie die folgenden Informationen angeben:

- Kaufbeleg
- Eine detaillierte Beschreibung des Problems.
- Klare und vollständige Fotos des Problems.

Anschließend wird Ihr Garantie Reklamation sorgfältig geprüft.

## **Wartungsempfehlungen:**

- Um Langlebigkeit und ästhetischen Reiz sicherzustellen, ist regelmäßige Wartung unerlässlich.  
Wir empfehlen:
- Ein- oder zweimal im Jahr (oder öfter) mit klarem Wasser und einem weichen Schwamm oder Tuch zu reinigen.
- Verwenden Sie während der Reinigung keine Reinigungsmittel oder abrasive Materialien.
- Überprüfen Sie regelmäßig die Festigkeit der Schrauben (mindestens einmal im Jahr).
- Tragen Sie WD-40 (oder ein ähnliches Produkt) auf die Befestigungen auf, um sie zu reinigen und die Oberflächenrostbeständigkeit zu erhöhen.
- Stellen Sie sicher, dass das Regenwasser in den Regenrinnen ungehindert fließen kann (entfernen Sie Blätter, Äste usw.).



## Informations importantes:

### Préparation de l'assemblage/ Liste de contrôle:

Avant de commencer l'assemblage, veuillez vous assurer que:

- Toutes les pièces énumérées sont fournies et intactes.
- Signalez toute pièce manquante dans les 14 jours dès réception de votre commande ET avant l'assemblage !
- Pour signaler les pièces manquantes, veuillez envoyer un mail au point de vente (magasin ou site web) où votre produit a été acheté.
- Ne jetez pas l'emballage sans avoir confirmé le bon fonctionnement du produit.

### Directives d'assemblage du produit:

- Évitez les jours de pluie, les vents dominants et les arbres en surplomb. Vérifiez la zone environnante pour détecter d'éventuels obstacles à proximité ou à l'intérieur du placement du produit.
- Assurez-vous qu'il y a au moins 1 personne supplémentaire présente lors de l'installation, cela favorise une installation plus rapide.
- Éloignez les enfants de la zone de rassemblement.
- Attention à éviter tout risque d'écrasement.
- Suivez attentivement toutes les étapes d'installation et vérifiez plusieurs fois le niveau à bulle et les angles du produit.
- Nous vous recommandons de revérifier le serrage de toutes les fixations concernées ainsi que le niveau de la construction principale avant de commencer l'installation des accessoires.
- Ancrez correctement la structure principale dans le sol ou les fondations avant d'ajouter des accessoires.
- Assurez-vous de conserver le manuel d'instructions et de ne pas le jeter après l'installation.
- L'utilisateur est responsable de tout dommage ou blessure causé par une installation incorrecte ou inappropriée.



### **Informations sur la garantie:**

La garantie constructeur s'applique aux défauts de fabrication et couvre le remplacement des pièces détachées ou des produit fourni ; aucun remboursement ne sera effectué. La garantie du fabricant ne couvre pas :

- L'usage normale.
- Perte ou casse lors du déballage ou de l'installation.
- Manque d'entretien, négligence, vandalisme, choc avec des objets externe, contact avec des matériaux abrasifs, esthétique, montage ou démontage incorrect, reconstruction ou déplacement, y compris, tous les points mentionnés dans le paragraphe ci-dessus relatif aux conditions météorologiques.
- Les événements de force majeure tels que la grêle, les vents violents, les tempêtes, la neige, les inondations, la foudre, etc.
- La modification du produit annule la garantie ; les produits altérés par l'utilisateur ne sont pas couverts.

Toutes les demandes de garantie doivent être adressées au point de vente (magasin ou site web) où votre produit a été acheté. Assurez-vous d'inclure les informations suivantes :

- Preuve d'achat
- Une description détaillée du problème.
- Photos claires et complètes du problème.

Votre réclamation sera ensuite soigneusement évaluée.

### **Recommandations d'entretien:**

Pour garantir la longévité et l'attrait esthétique, un entretien régulier est essentiel.

Nous recommandons :

- Nettoyer à l'eau claire, à l'aide d'une éponge ou d'un chiffon doux, une à deux fois par an (ou plus souvent).
- Éviter d'utiliser des détergents ou des matériaux abrasifs lors du nettoyage.
- Vérifier régulièrement le serrage des vis (au moins une fois par an).
- Appliquer du WD-40 (ou un produit similaire) sur les fixations pour les nettoyer et augmenter la résistance à la rouille en surface.
- Assurez que l'eau s'écoule librement dans les gouttières (enlevez les feuilles, les branches, etc.).

# Required equipment/ Benodigde materialen/ Benötigte Ausrüstung/ Équipement requis

Tools/ Gereedschap/ Werkzeug/ Outils:

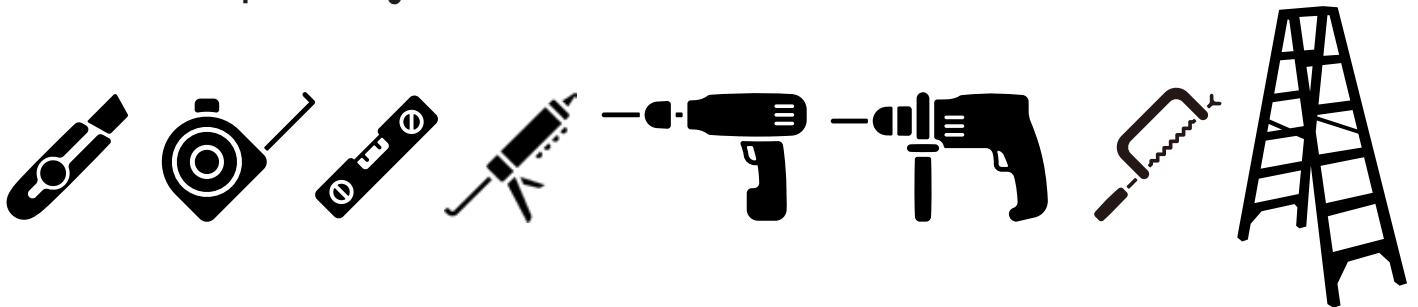

PPE/ PB/ PSA/ EPI:



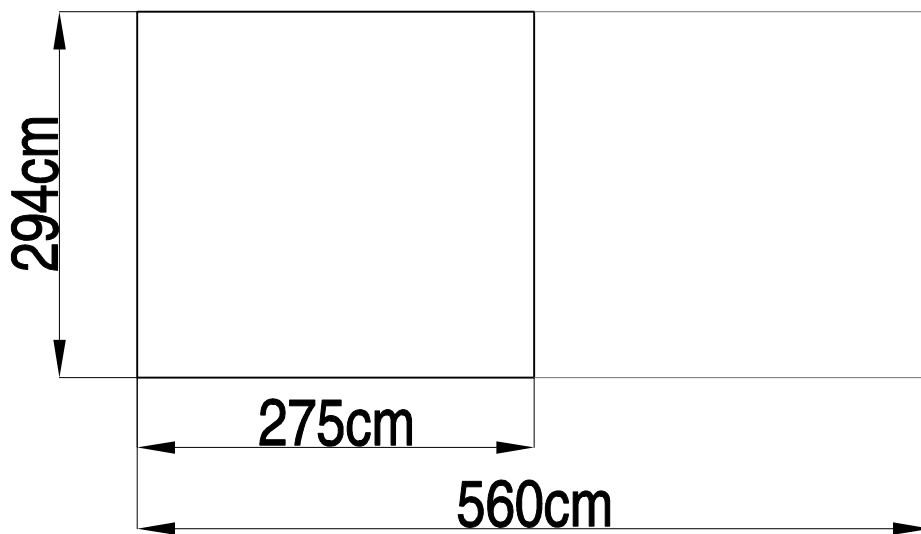
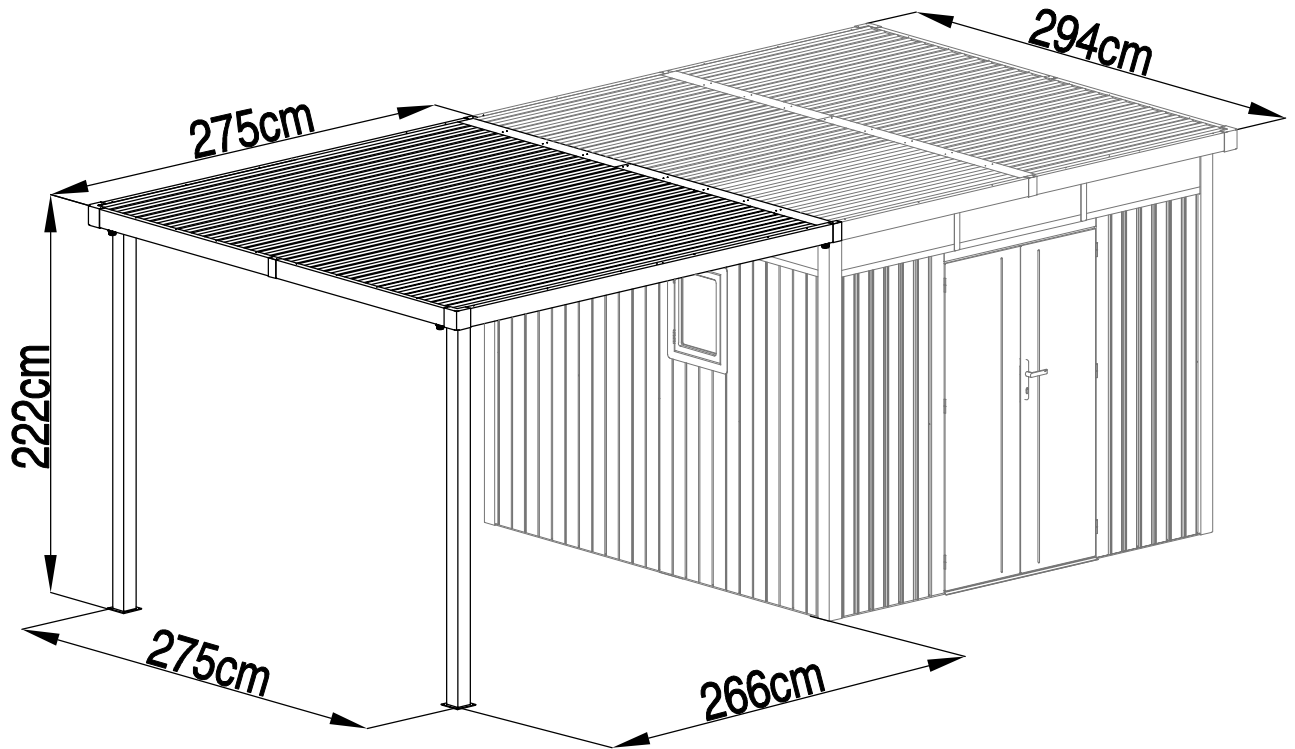







**Left Side Placement**



**Montage linkerzijde**



**Montage links**



**Montage côté gauche**

1

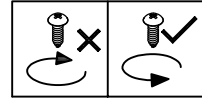
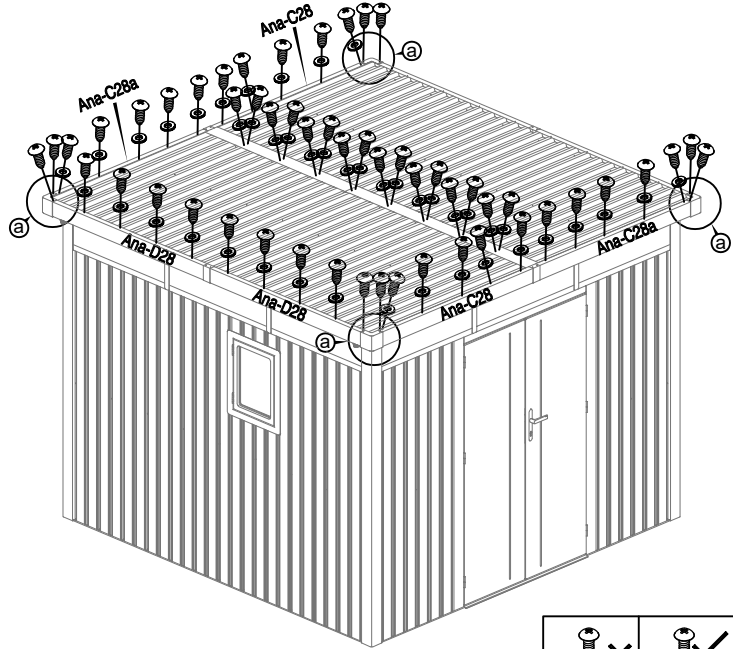
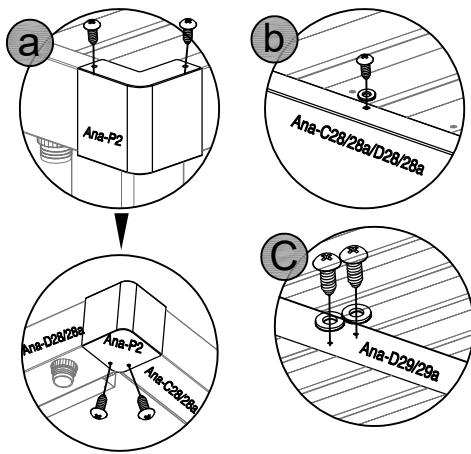

2

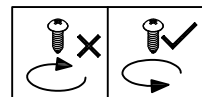
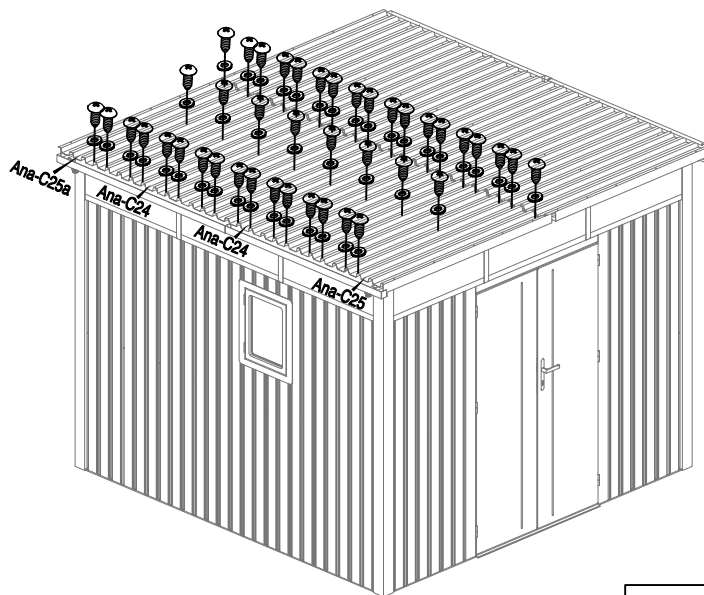
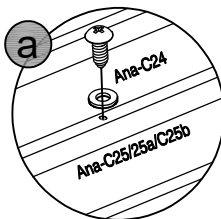

1



3

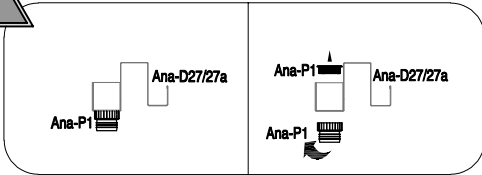

HANDLE WITH CARE

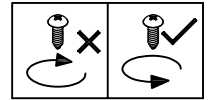
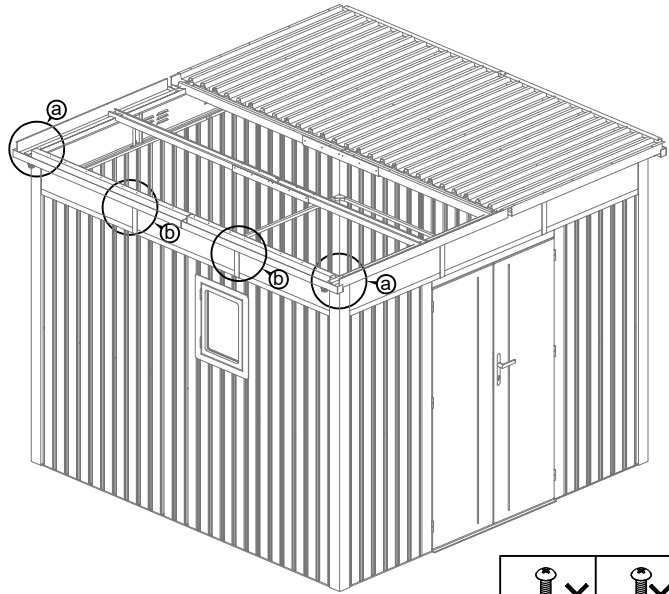
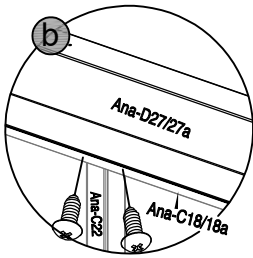
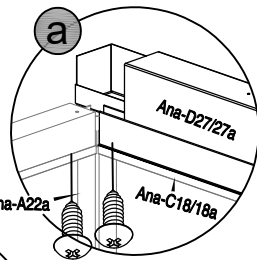

4



HANDLE WITH CARE

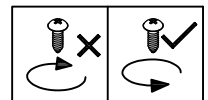
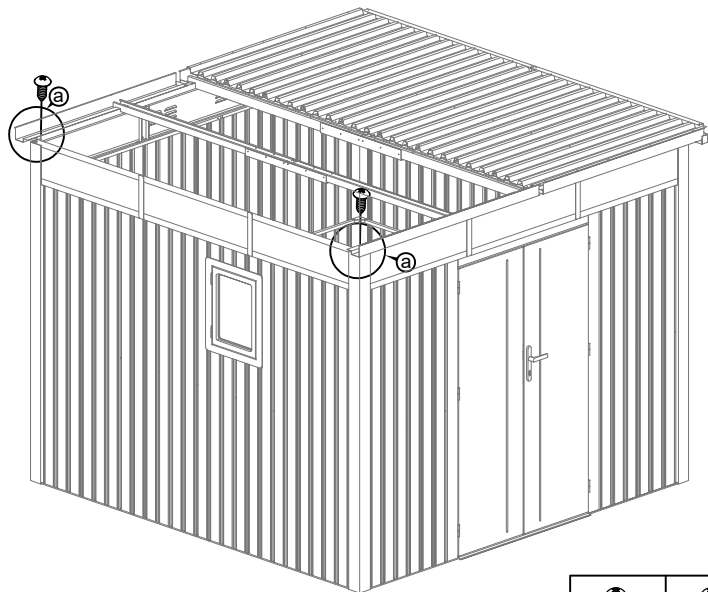
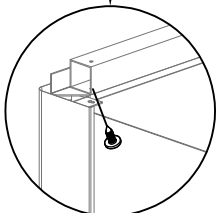
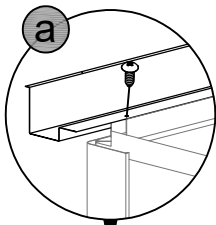



2



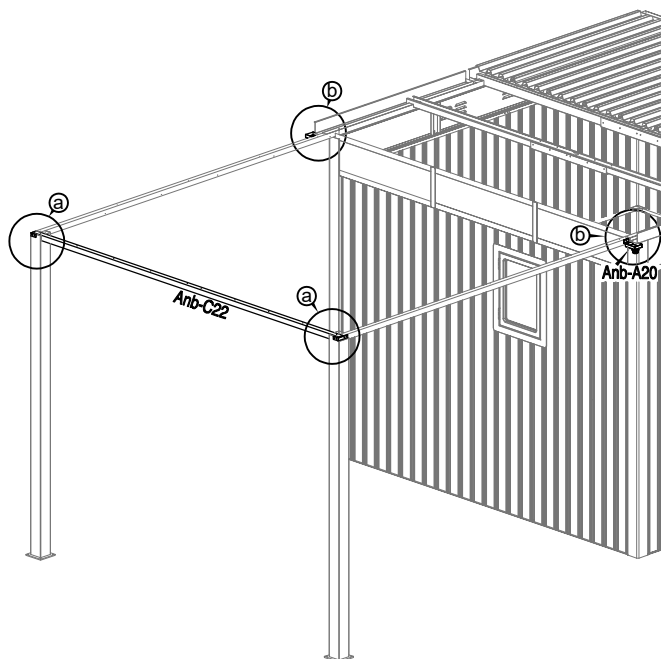
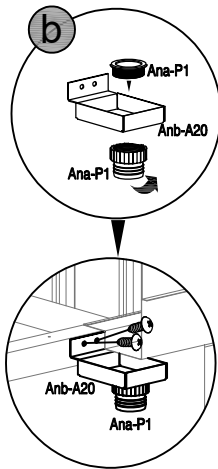
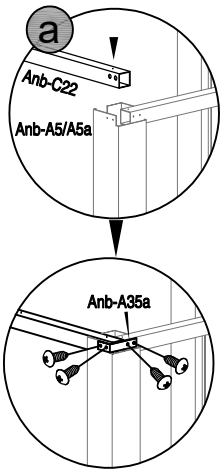
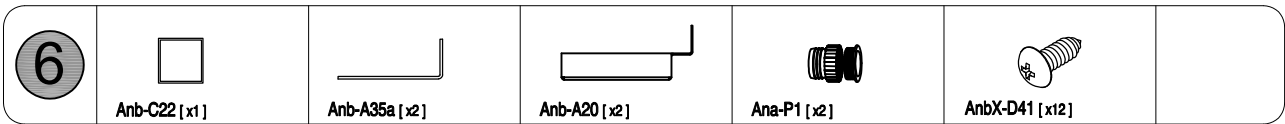
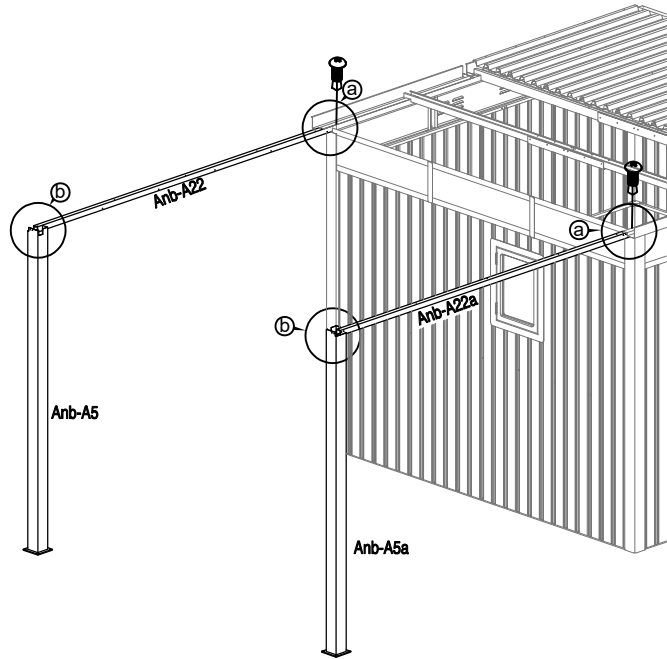
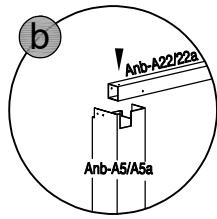
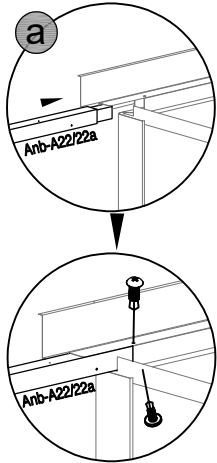
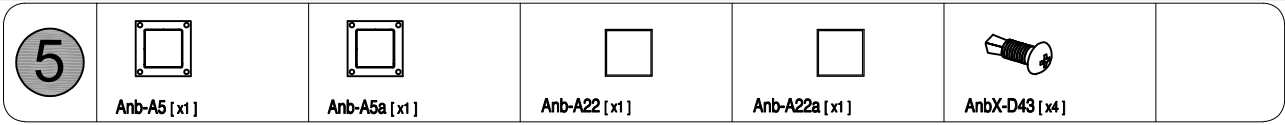



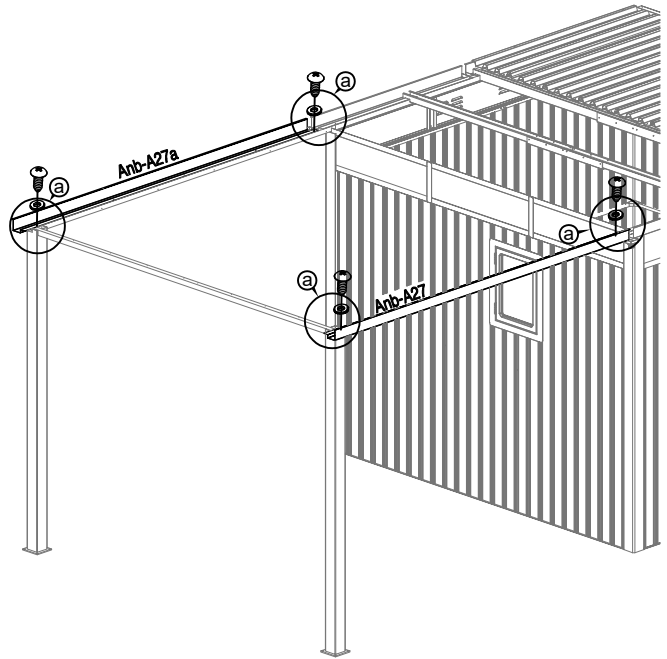
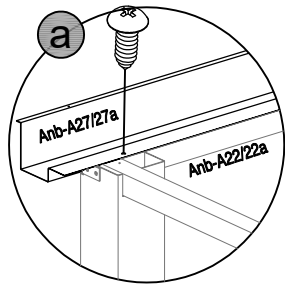

<b>7</b>	 Anb-A27 [x1]	 Anb-A27a [x1]	 AnbX-D41 [x4]	
----------	---	--	--	--



<b>8</b>	 Anb-C26 [x1]	 AnbX-D41 [x6]	 AnbX-D40 [x2]	
----------	---	--	--	--

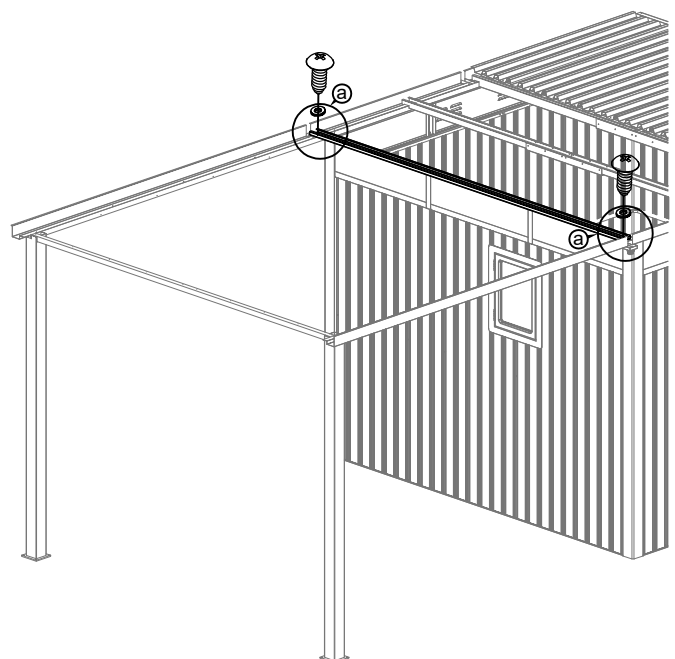
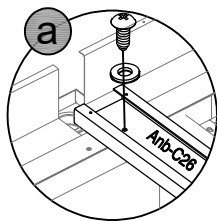

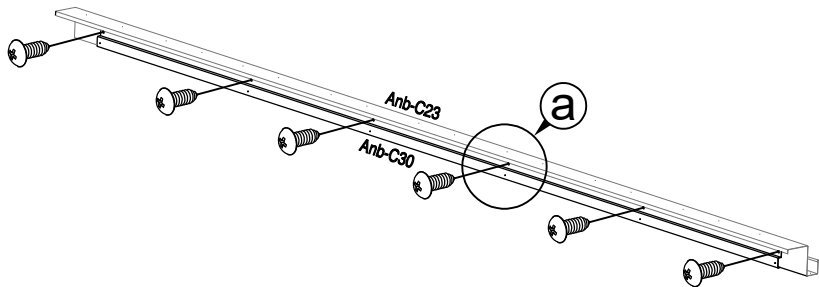
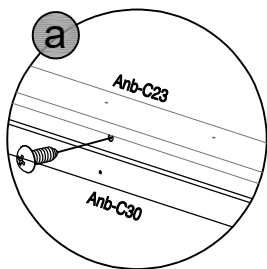

<b>9</b>	 Anb-C30 [x1]	 Anb-C23 [x1]	 AnbX-D41 [x6]	
----------	---	---	--	--

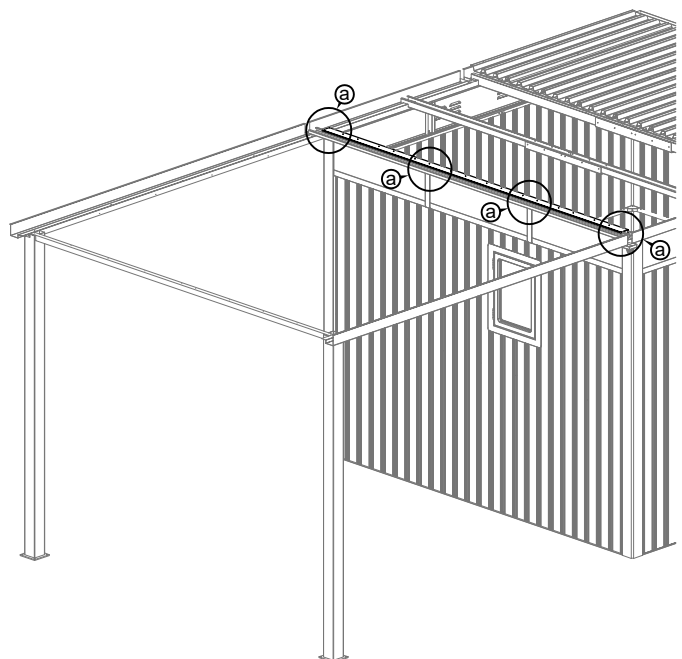
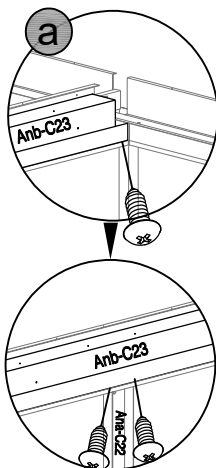
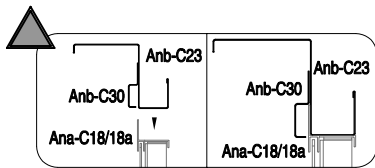

<b>10</b>	 AnbX-D41 [x6]	
-----------	--	--





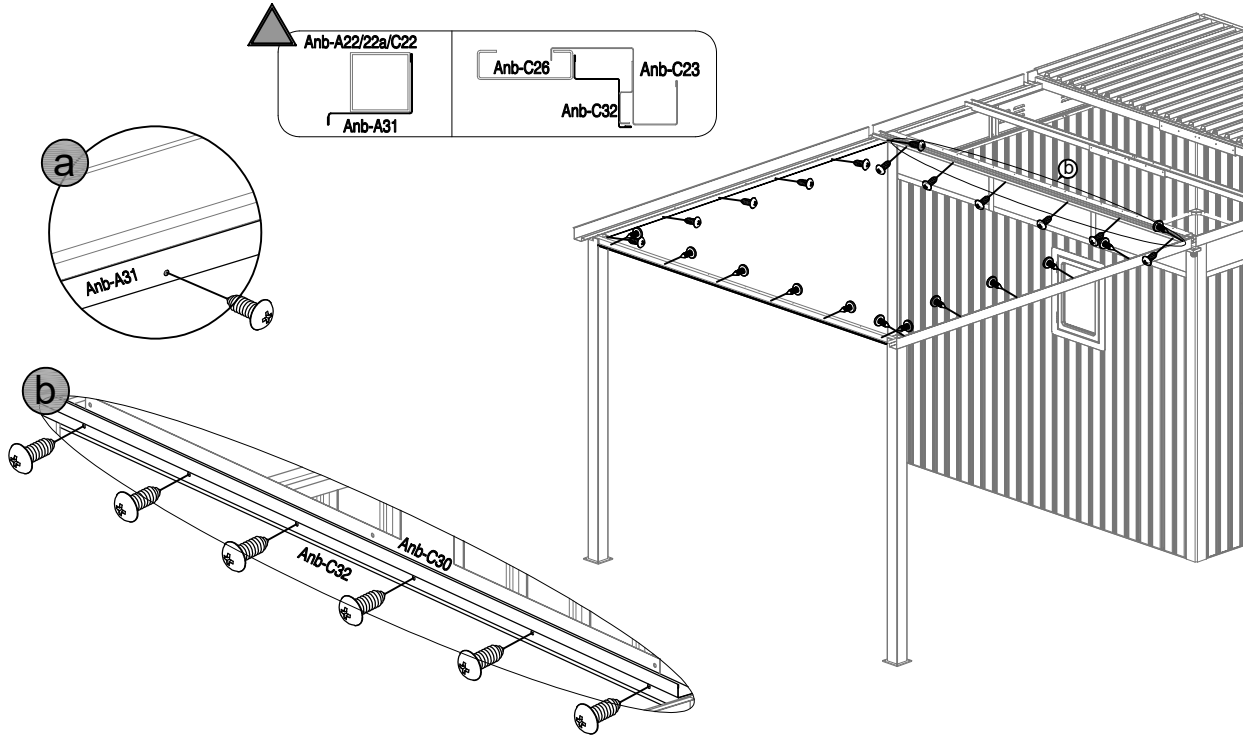

<b>11</b>	 Anb-B32 [x1]	 Anb-A31 [x3]	 AnbX-D41 [x24]
-----------	---	---	---

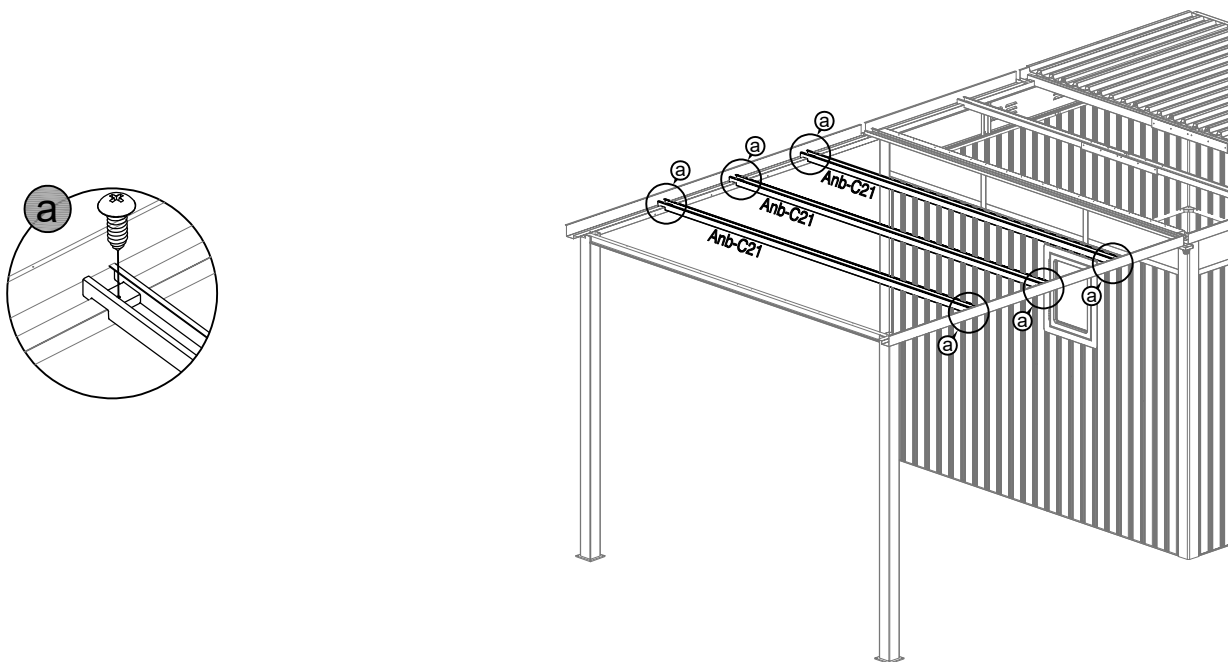



<b>12</b>	 Anb-C21 [x3]	 AnbX-D41 [x6]
-----------	---	--

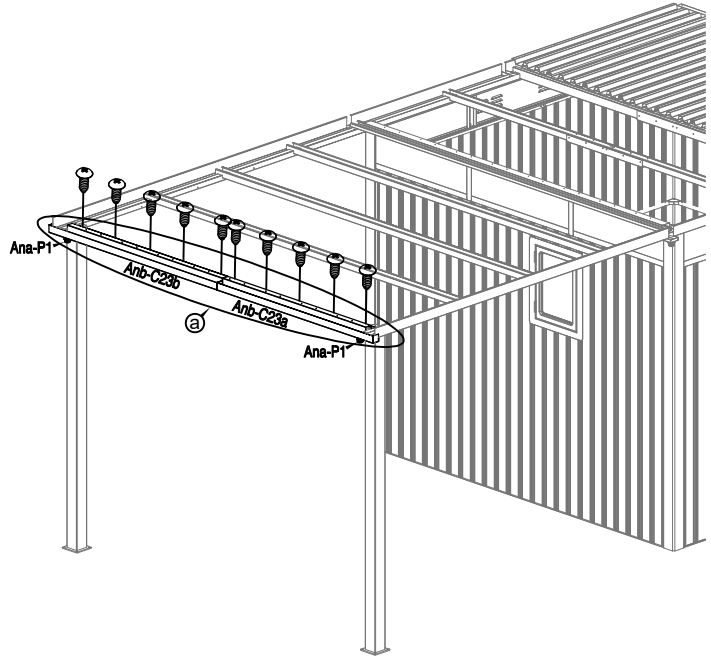
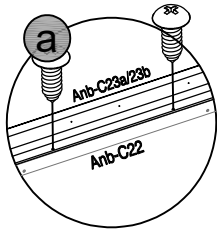
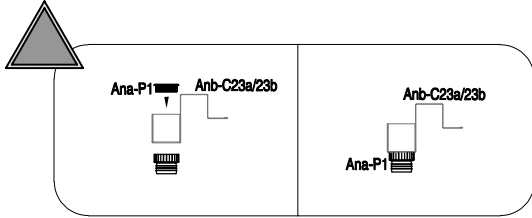

<b>13</b>	 Anb-C23a [x1]	 Anb-C23b [x1]	 Ana-P1 [x2]	 AnbX-D41 [x10]	
-----------	--	--	--	--	--

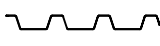

<b>14</b>	 Anb-A25 [x1]	 Ana-C25a [x1]	 AnbX-D41 [x5]	 AnbX-D40 [x5]	
-----------	---	--	--	---	--

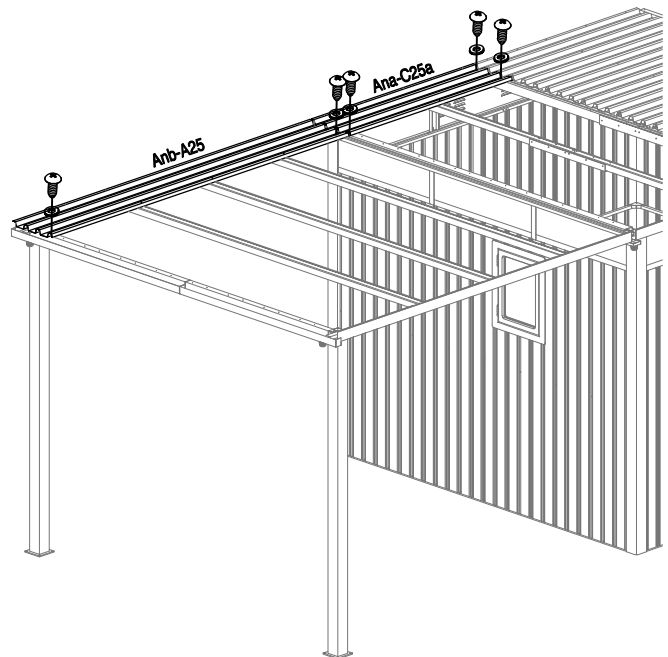
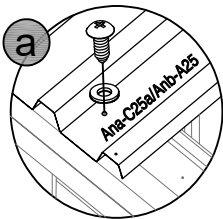

**EN:** To improve water tightness, place sealant in between panel connections and screw holes. Use sealant which retains elasticity. (Not included)





**NL:** Om de waterdichtheid te verbeteren, plaatst u kit tussen de paneelverbindingen en schroefgaten. Gebruik kit die de elasticiteit behoudt. (Niet inbegrepen)

**DE:** Um die Wasserdichtigkeit zu verbessern, platzieren Sie Dichtungsmittel zwischen Plattenverbindungen und Schraubenlöchern. Verwenden Sie Dichtungsmittel, das elastisch bleibt. (Nicht im Lieferumfang enthalten)

**FR:** Pour améliorer l'étanchéité, placez du mastic entre les connexions des panneaux et les trous de vis. Utilisez un mastic qui conserve son élasticité. (Non inclus)





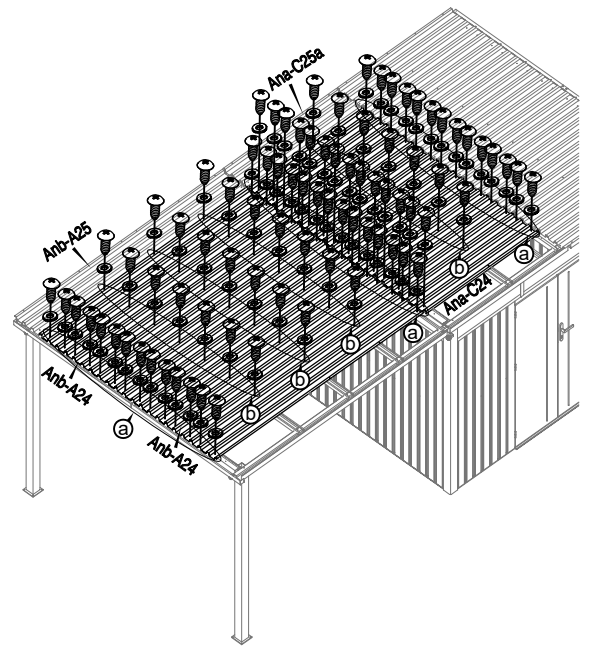
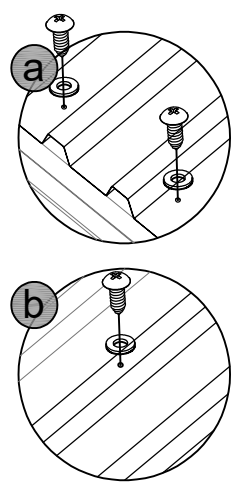
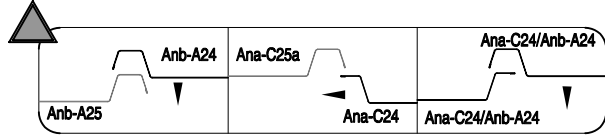

**15**





			
Anb-A24 [x7]	Ana-C24 [x7]	AnbX-D41 [x84]	AnbX-D40 [x84]



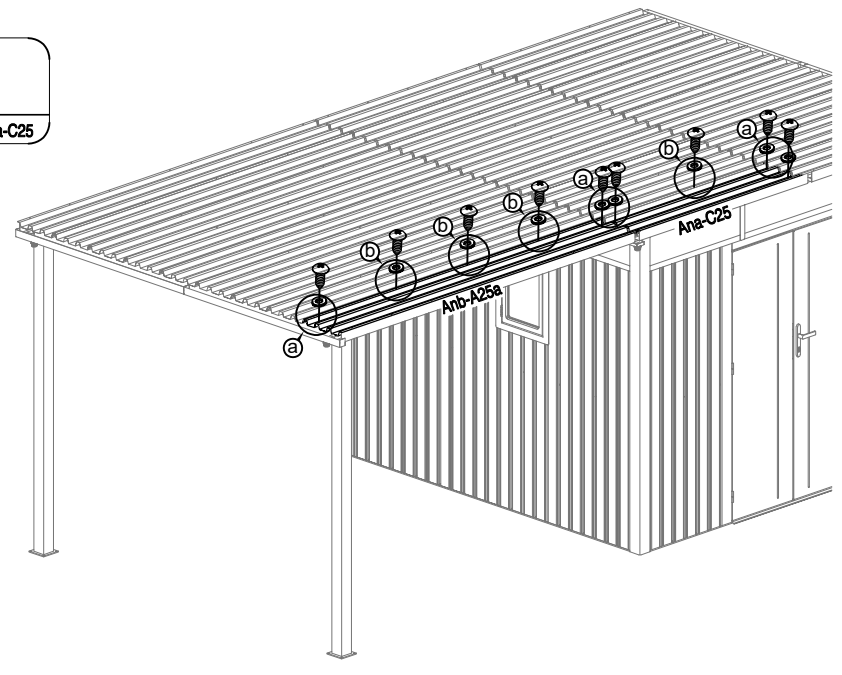
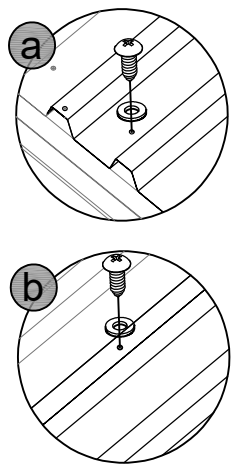
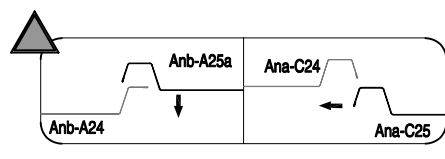

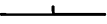



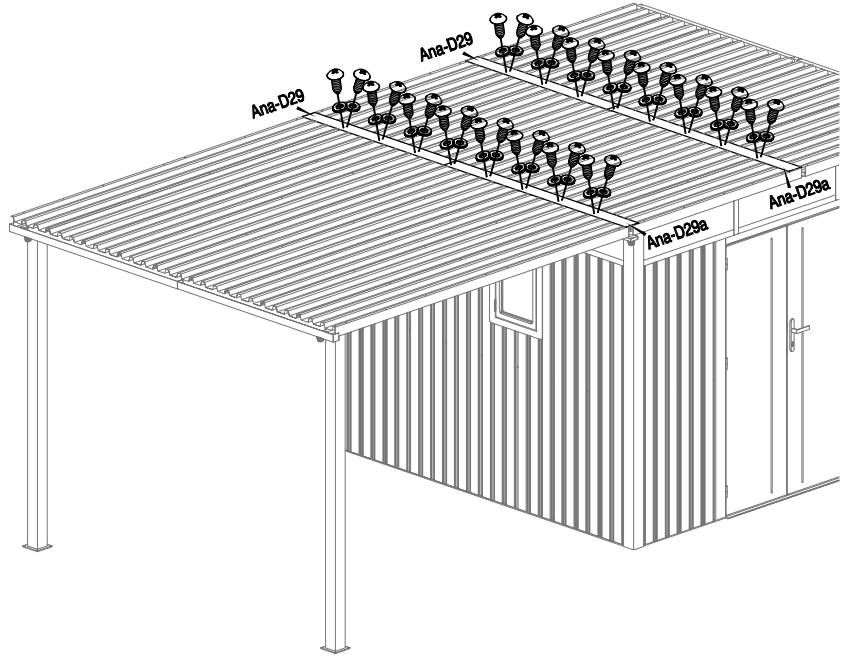
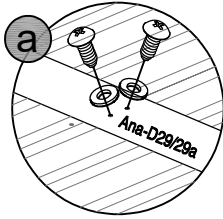

**16**

			
Anb-A25a [x1]	Ana-C25 [x1]	AnbX-D41 [x9]	AnbX-D40 [x9]



<b>17</b>	 Ana-D29 [x2]	 Ana-D29a [x2]	 AnbX-D47 [x32]	 AnbX-D40 [x32]
-----------	---	--	---	---



<b>18</b>	 Anb-A28 [x1]	 Anb-A28a [x1]	 Anb-A35 [x2]	 Ana-C35a [x2]	 Anb-A36 [x2]	 AnbX-D41 [x4]	 AnbX-D42 [x8]	 AnbX-D40 [x4]
-----------	---	--	---	--	---	--	--	--

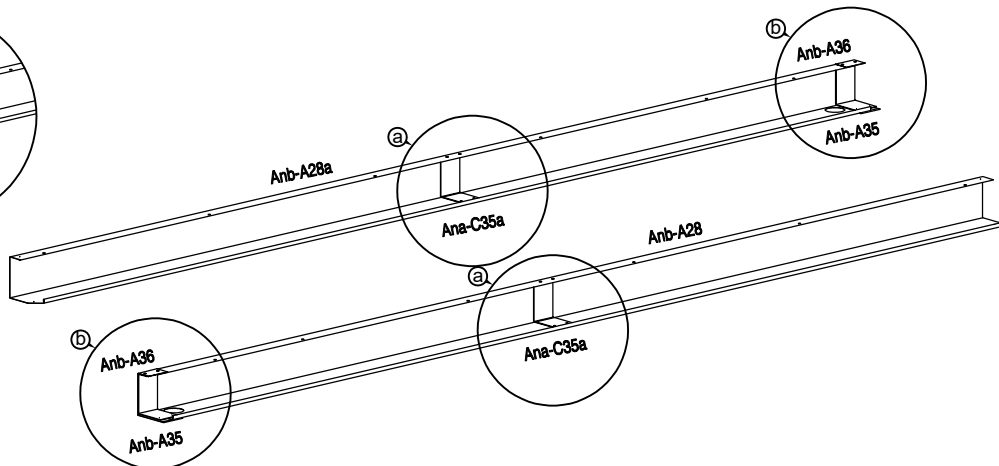
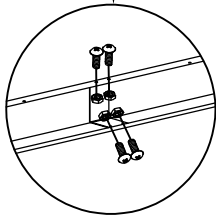
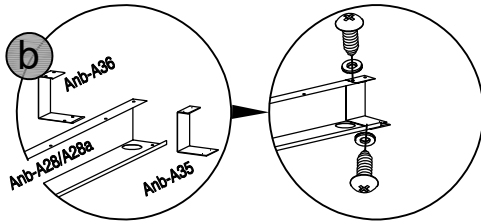
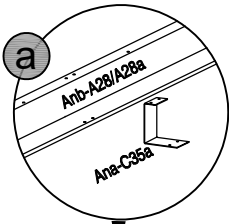

19



AnbX-D41 [x22]



AnbX-D40 [x22]

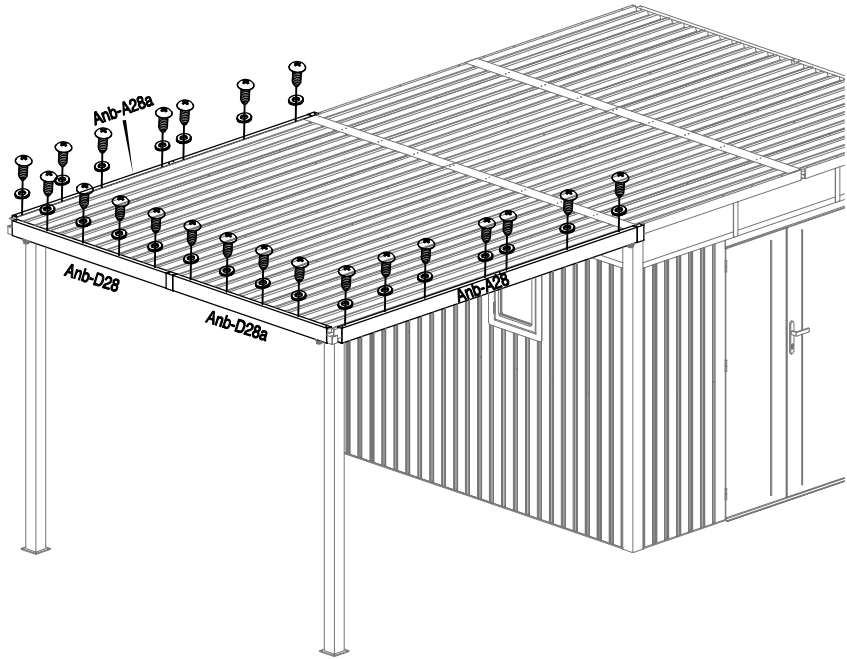
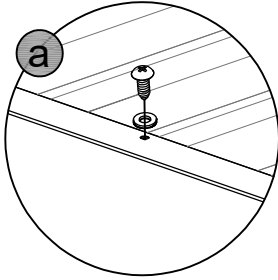

20



AnaX-D41 [x20]



AnbX-D40 [x20]

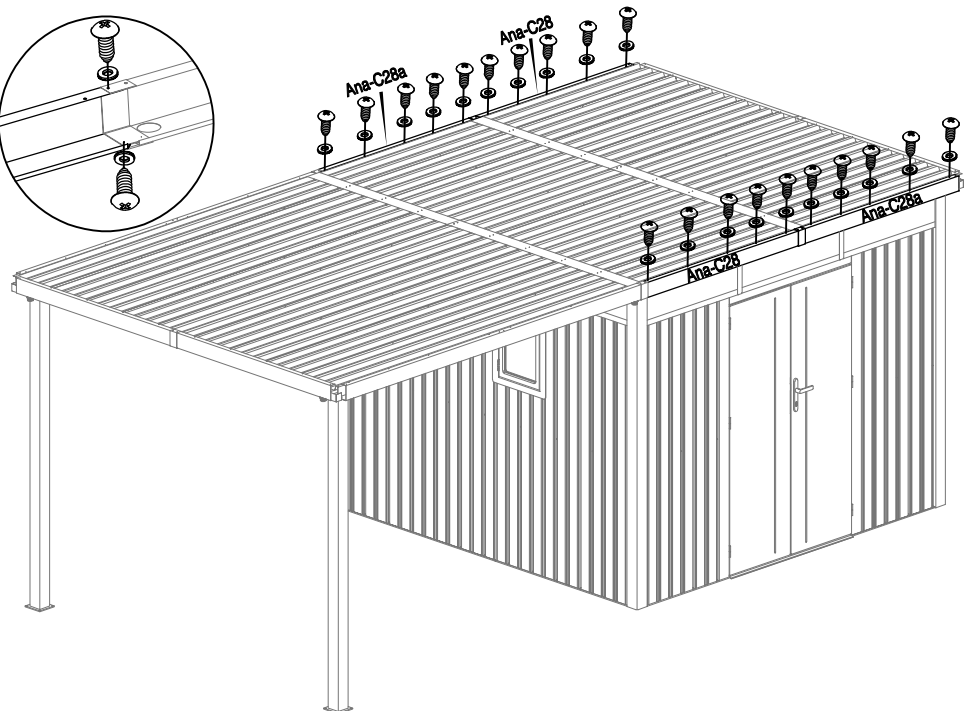
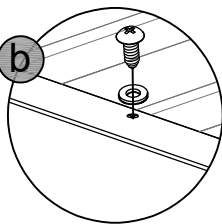
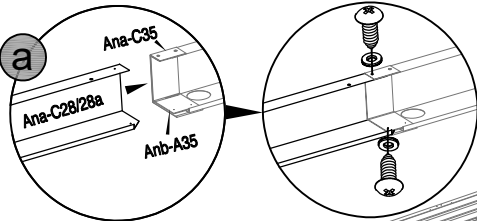



21



Ana-P2 [x4]



AnbX-D41 [x16]

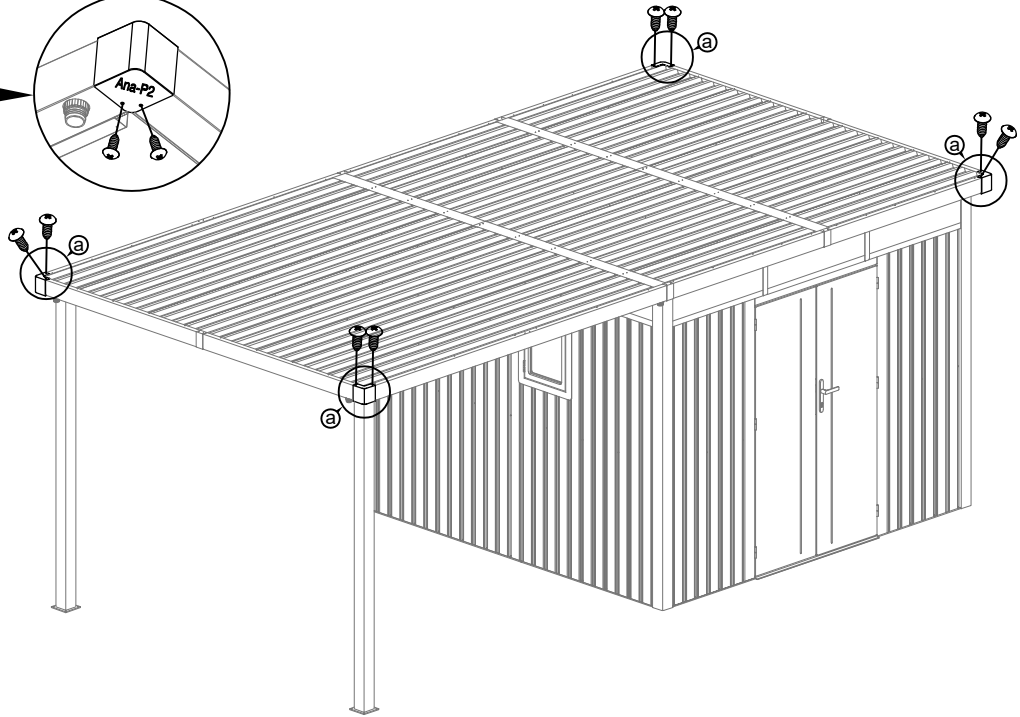
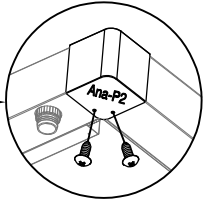
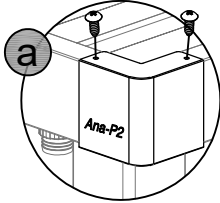

22



Anb-45 [x8]

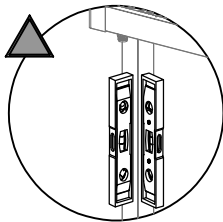

$B=A$

$D=C$

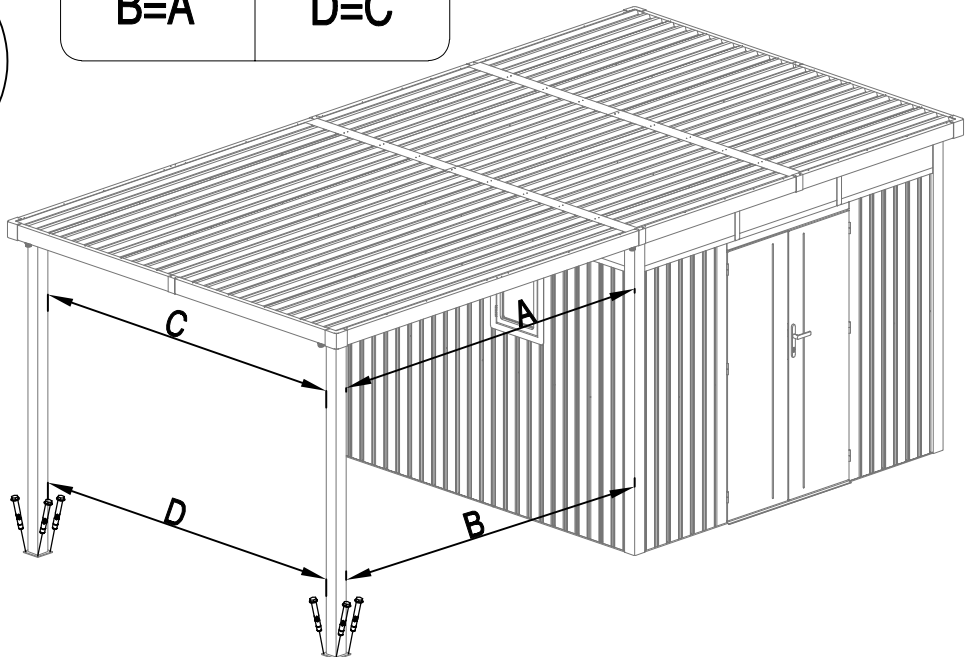
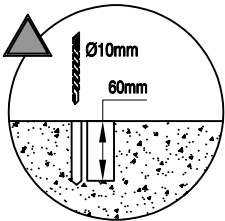

11





**Right Side Placement**



**Montage Rechterzijde**



**Montage Rechts**



**Montage côté droit**

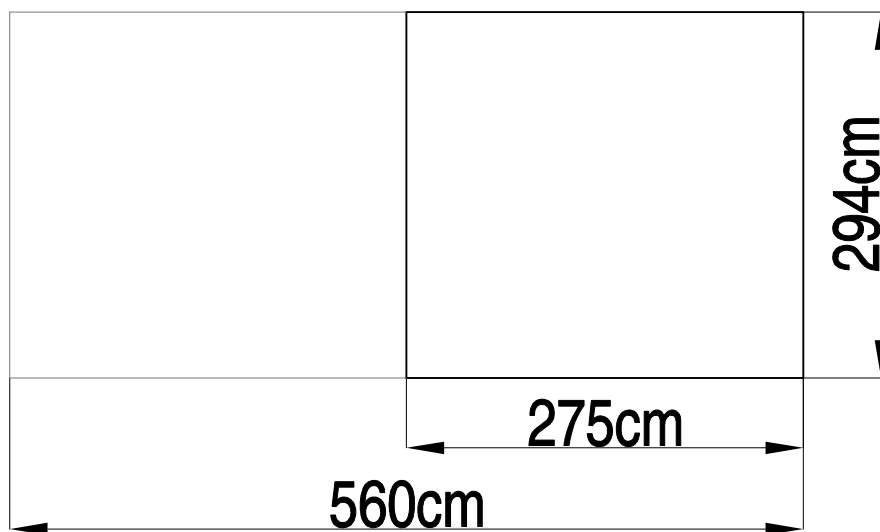
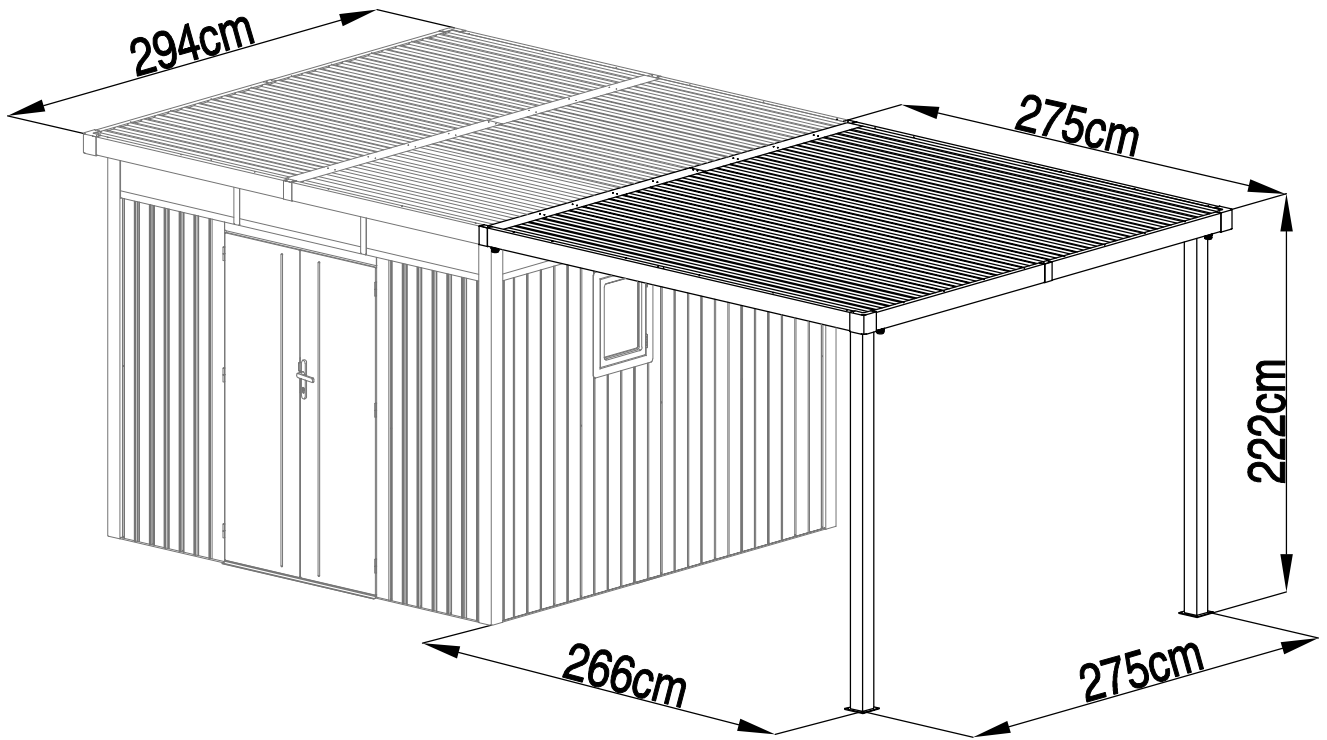



1

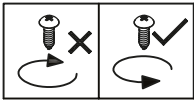
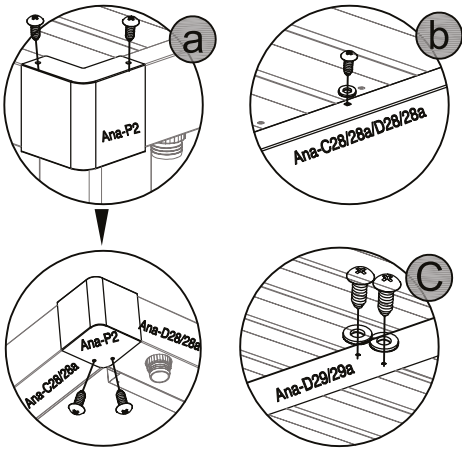
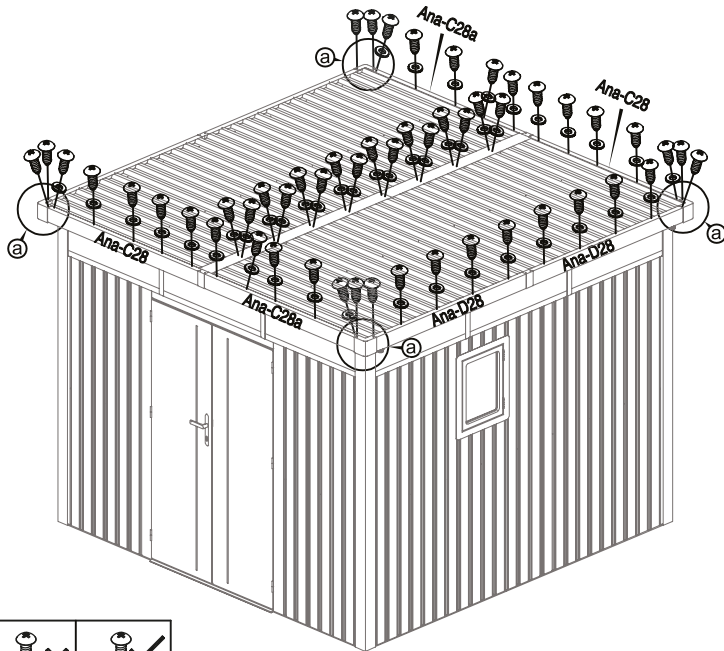

2

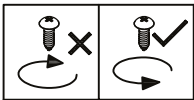
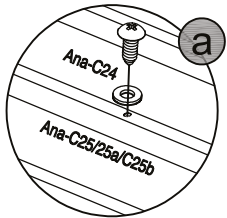
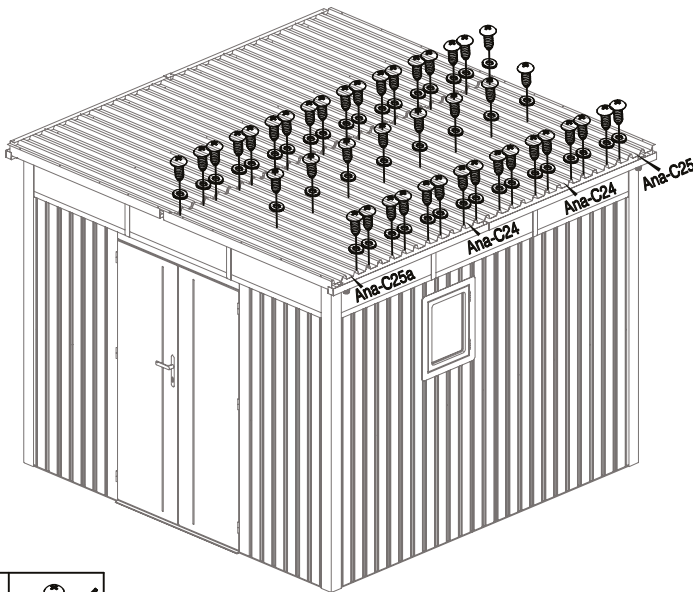

1



3

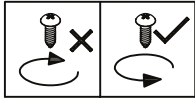
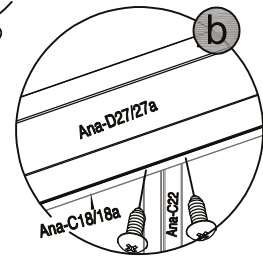
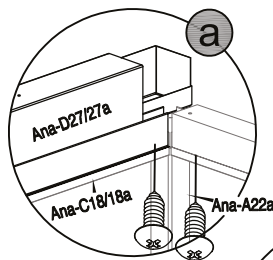
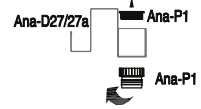
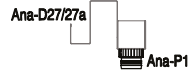
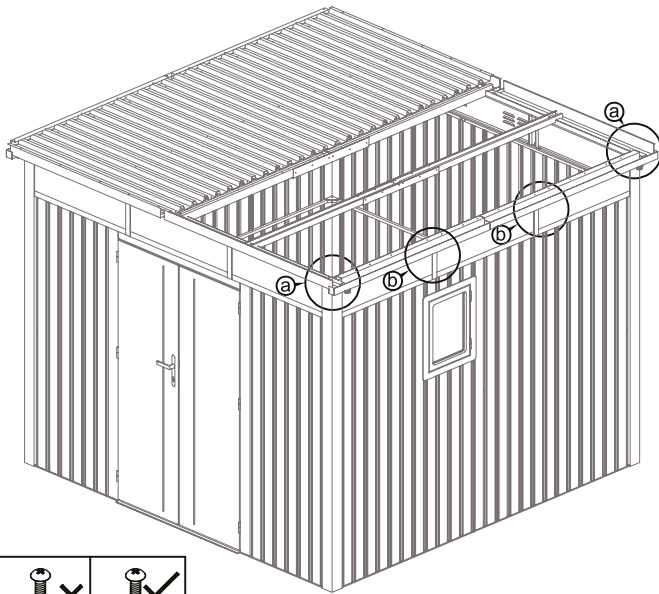

4

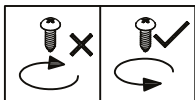
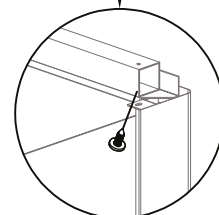
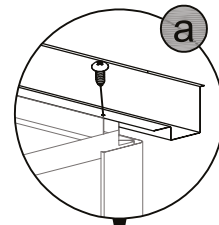
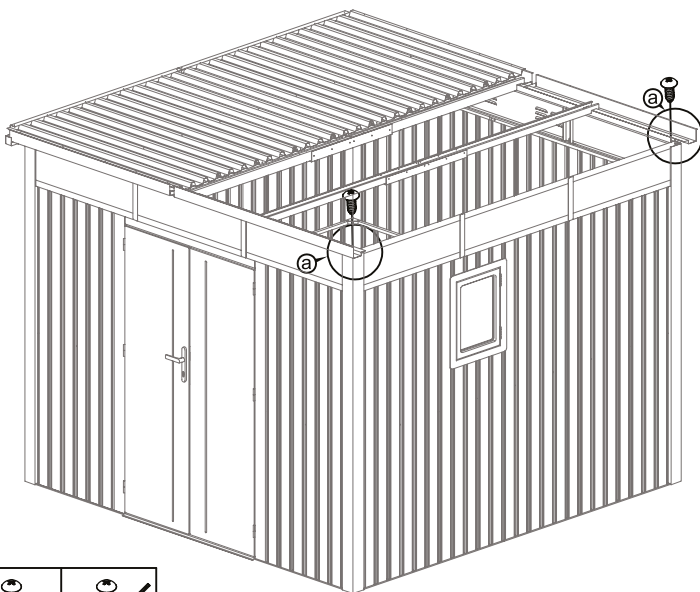

2



<b>5</b>					
	Anb-A5 [x1]	Anb-A5a [x1]	Anb-A22 [x1]	Anb-A22a [x1]	AnbX-D43 [x4]

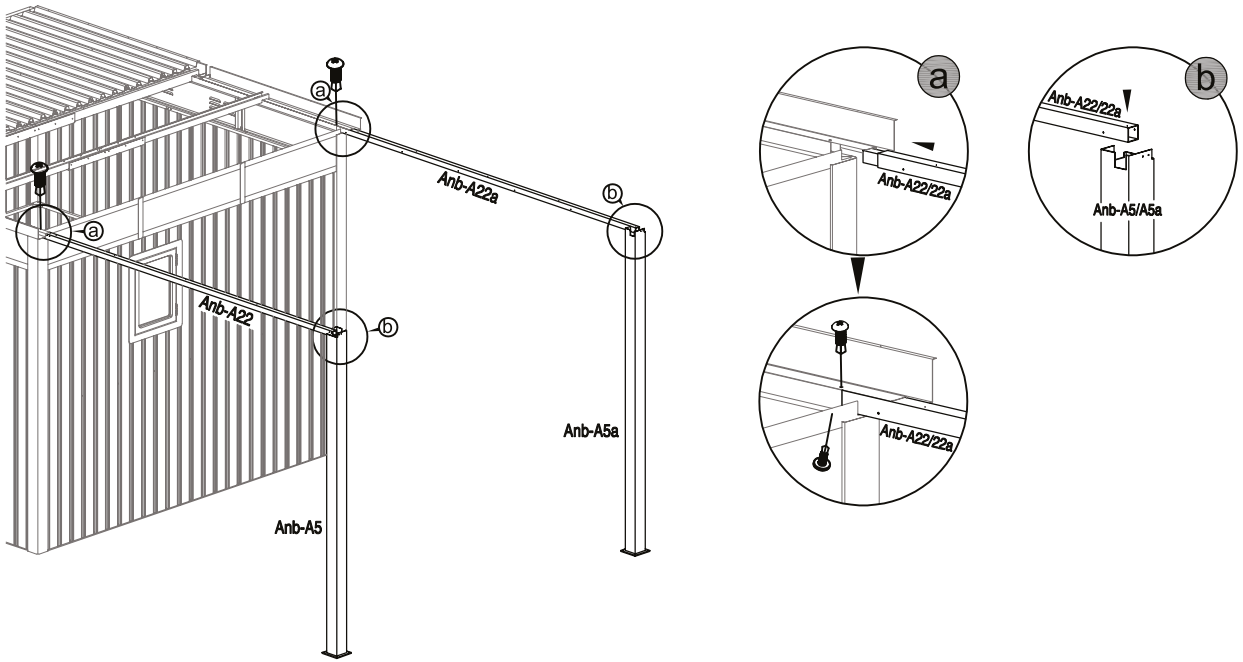

<b>6</b>					
	Anb-C22 [x1]	Anb-A35a [x2]	Anb-A20 [x2]	Ana-P1 [x2]	AnbX-D41 [x12]

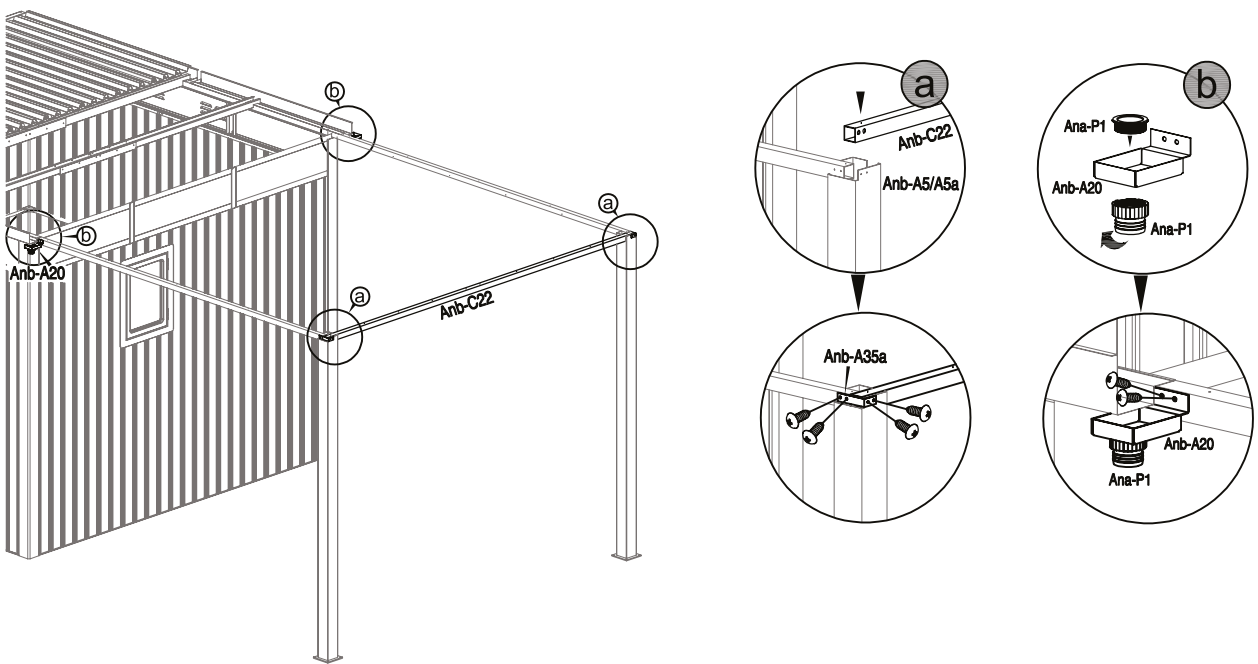

7

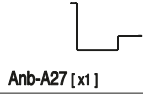

Anb-A27 [x1]

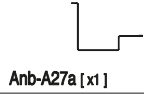

Anb-A27a [x1]



AnbX-D41 [x4]

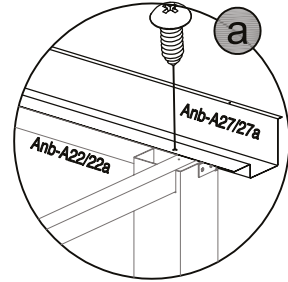
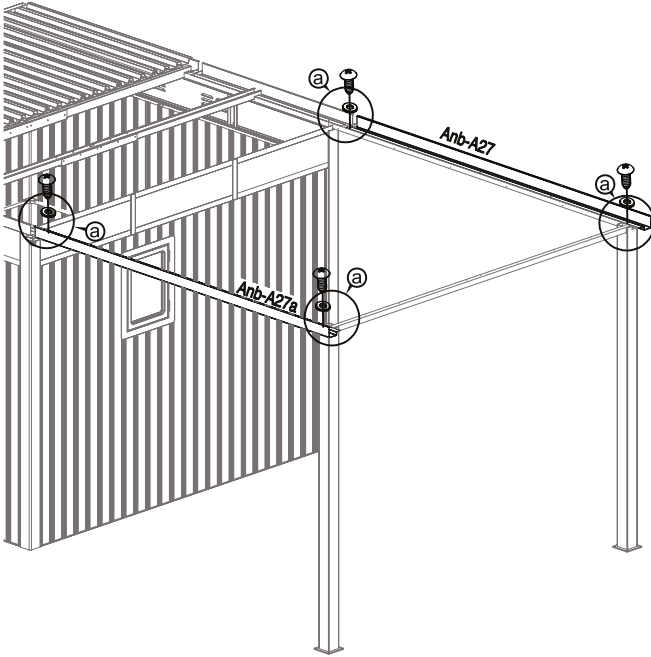

8

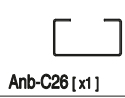

Anb-C26 [x1]



AnbX-D41 [x6]



AnbX-D40 [x2]

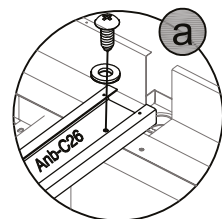
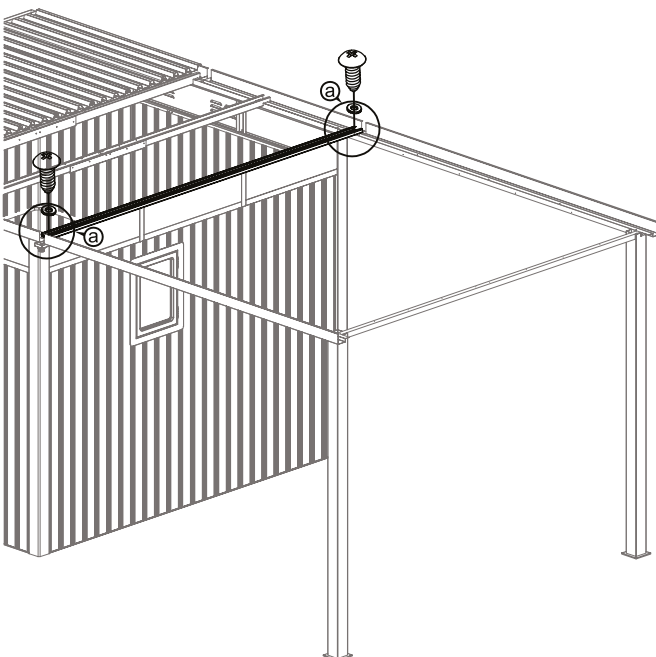



9

Anb-C30 [x1]

Anb-C23 [x1]

AnbX-D41 [x6]

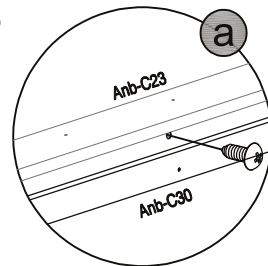
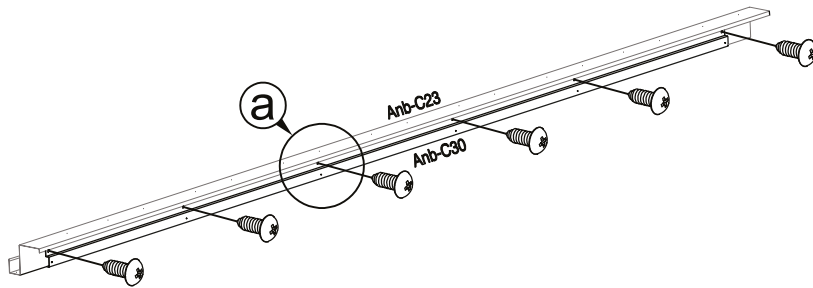
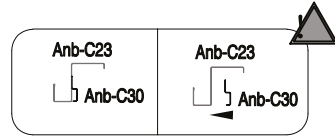

10

AnbX-D41 [x6]

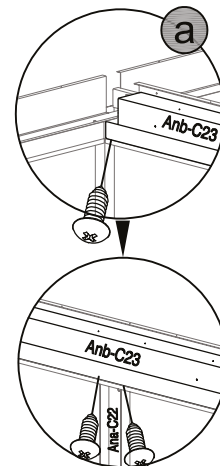
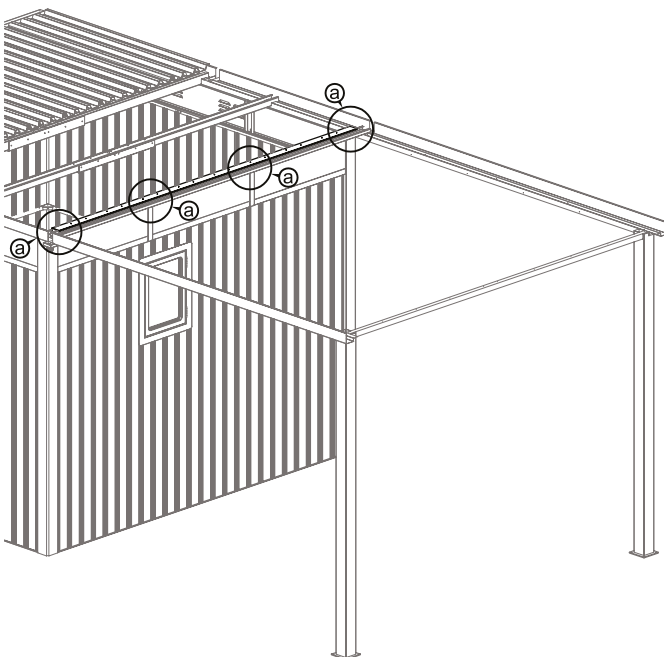
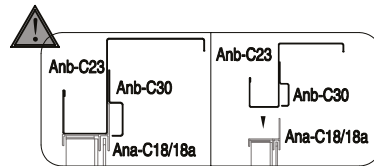

5



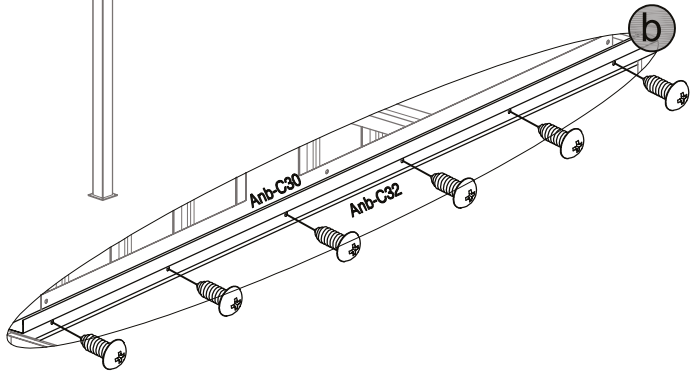
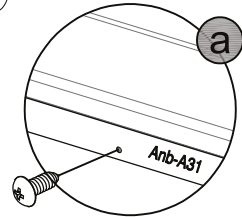
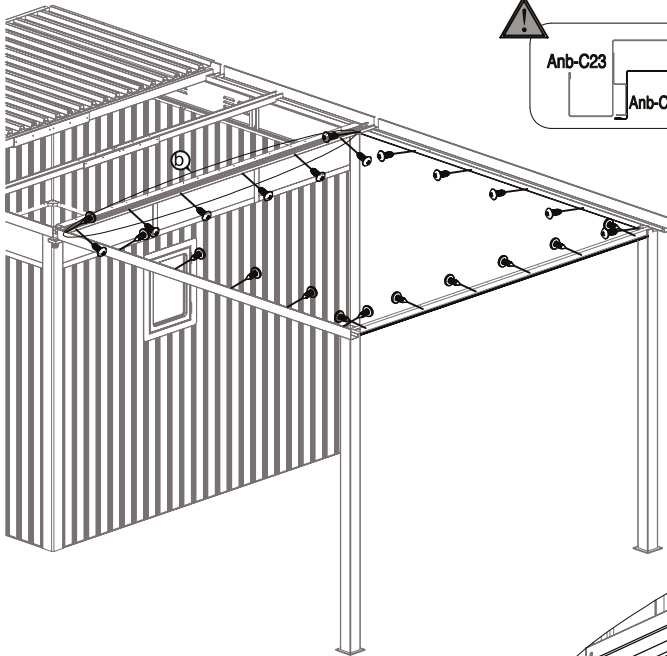
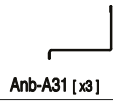
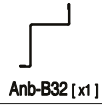

11



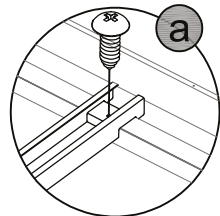
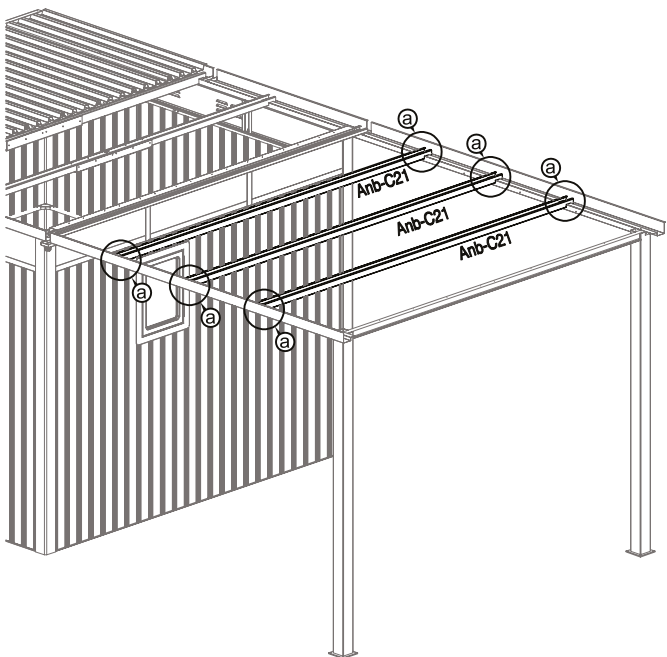

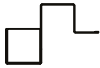
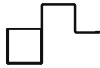

12

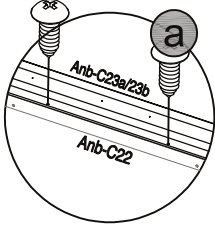
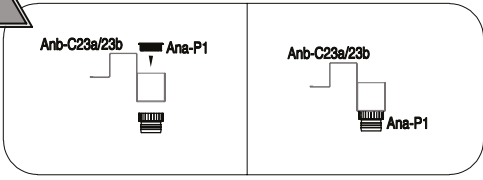
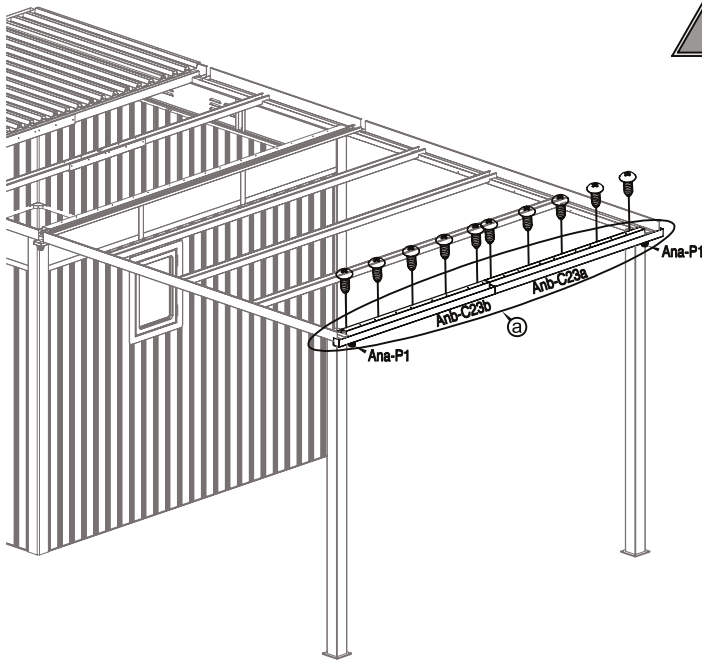

13	 Anb-C23a [x1]	 Anb-C23b [x1]	 Ana-P1 [x2]	 AnbX-D41 [x10]	
----	--	--	--	--	--



14	 Anb-A25a [x1]	 Ana-C25 [x1]	 AnbX-D41 [x5]	 AnbX-D40 [x5]	
----	--	---	--	---	--

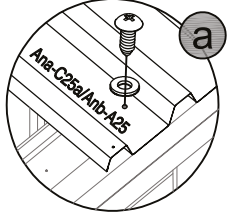
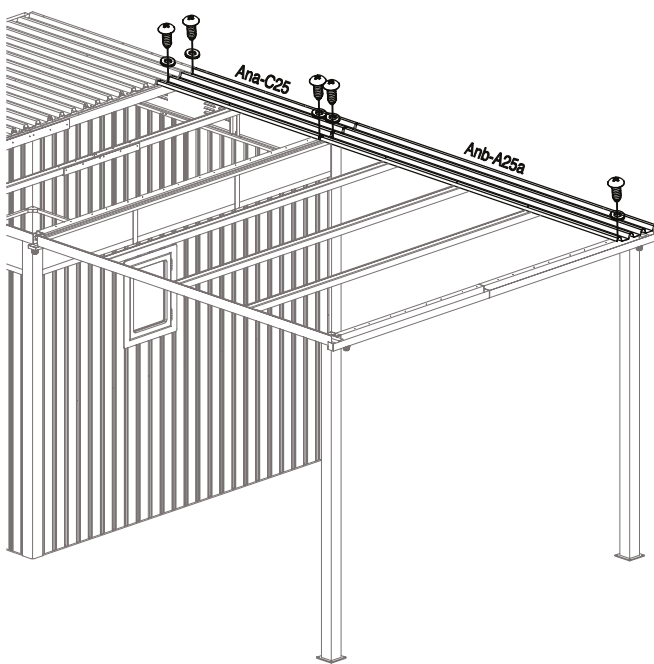

EN: To improve water tightness, place sealant in between panel connections and screw holes.



Use sealant which retains elasticity. (Not included)

NL: Om de waterdichtheid te verbeteren, plaatst u kit tussen de paneelverbindingen en schroefgaten. Gebruik kit die de elasticiteit behoudt. (Niet inbegrepen)



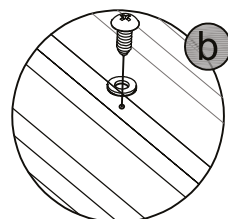
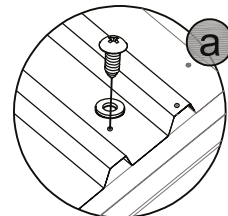
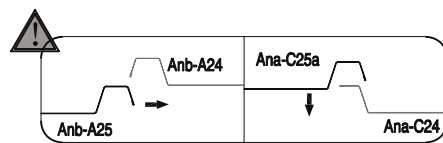
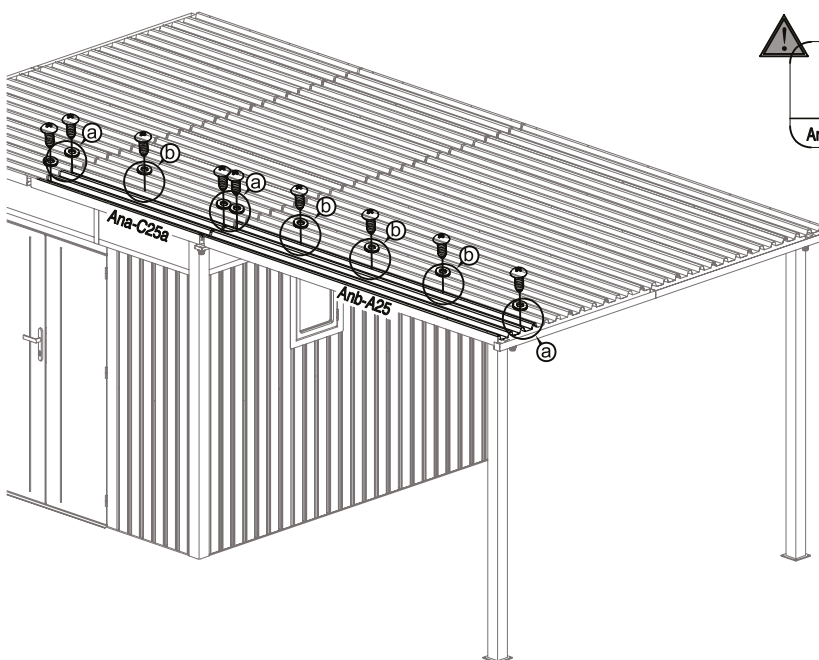
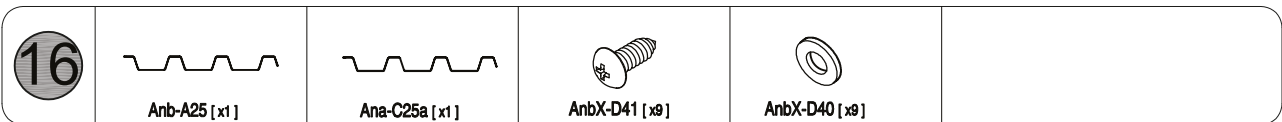
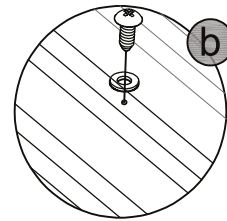
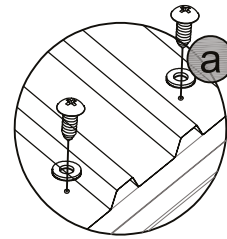
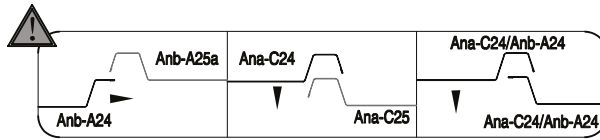
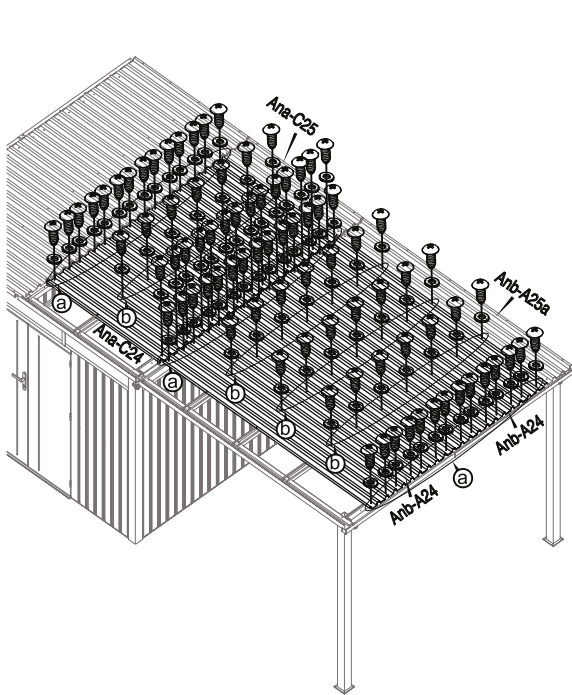
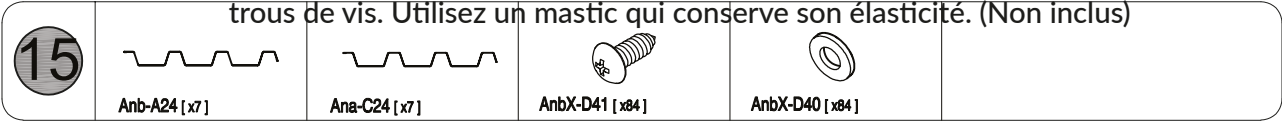

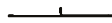

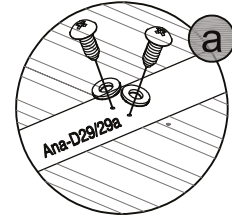
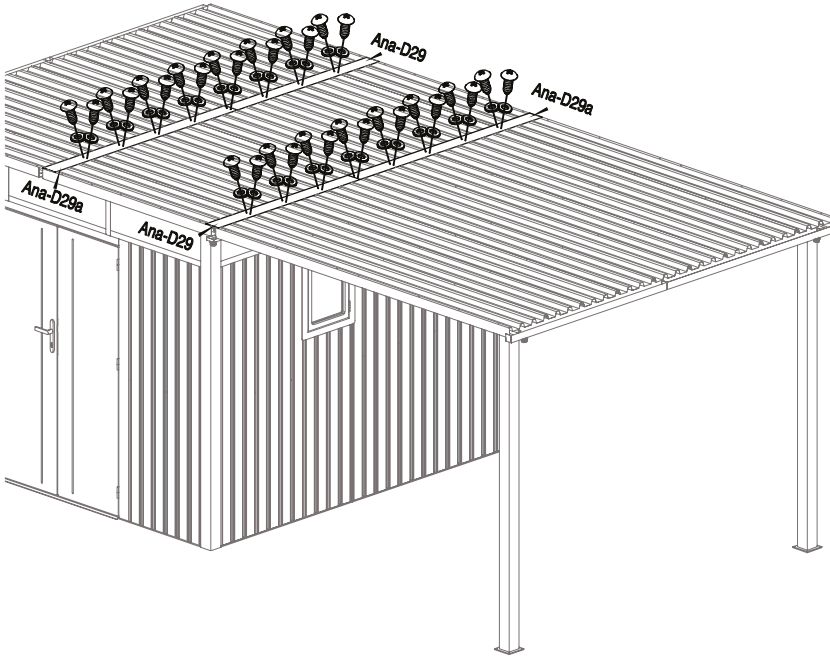

DE: Um die Wasserdichtigkeit zu verbessern, platzieren Sie Dichtungsmittel zwischen Plattenverbindungen und Schraubenlöchern. Verwenden Sie Dichtungsmittel, das elastisch bleibt. (Nicht im Lieferumfang enthalten)

FR: Pour améliorer l'étanchéité, placez du mastic entre les connexions des panneaux et les trous de vis. Utilisez un mastic qui conserve son élasticité. (Non inclus)



<b>17</b>	 Ana-D29 [x2]	 Ana-D29a [x2]	 AnbX-D47 [x32]	 AnbX-D40 [x32]	
-----------	---	--	---	--	--



<b>18</b>	 Anb-A28 [x1]	 Anb-A28a [x1]	 Anb-A35 [x2]	 Ana-C35a [x2]	 Anb-A36 [x2]	 AnbX-D41 [x4]	 AnbX-D42 [x8]	 AnbX-D40 [x4]
-----------	---	--	---	--	---	--	--	--

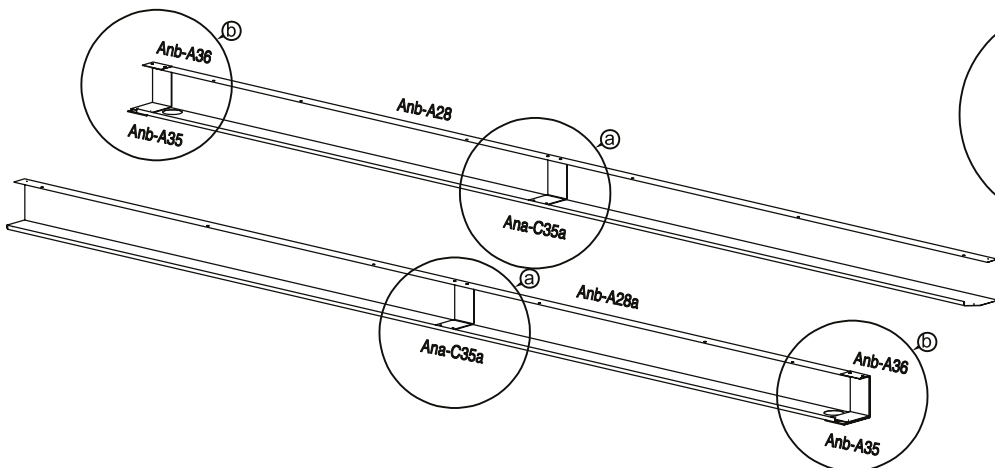
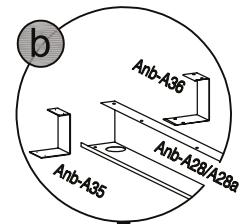
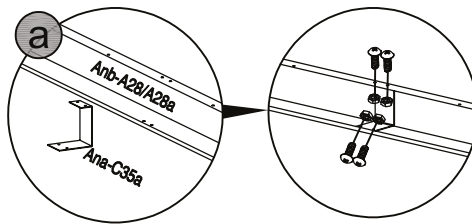

19

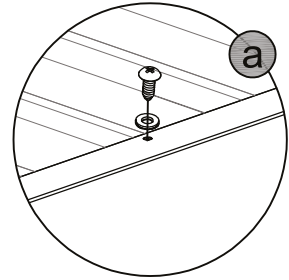
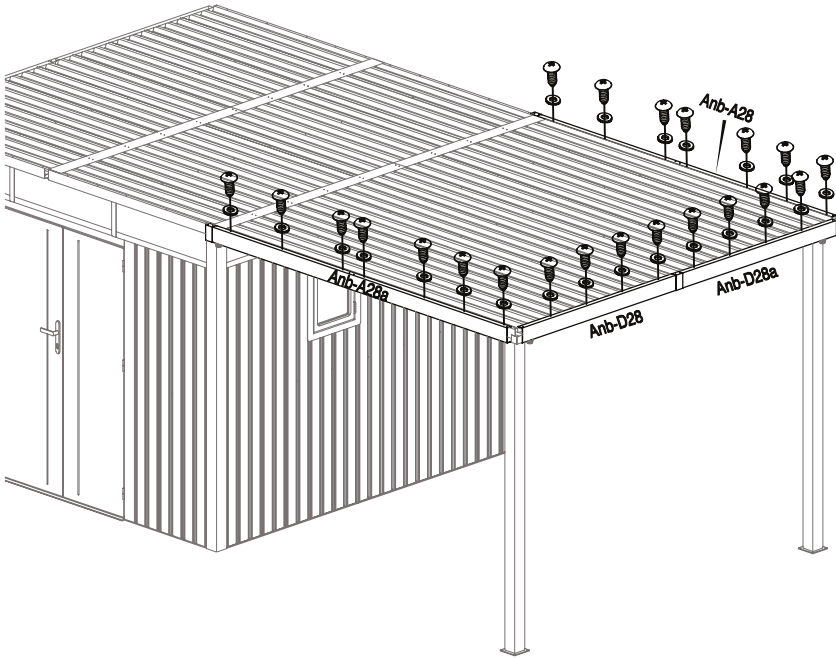
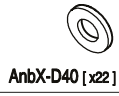

20

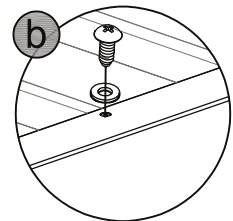
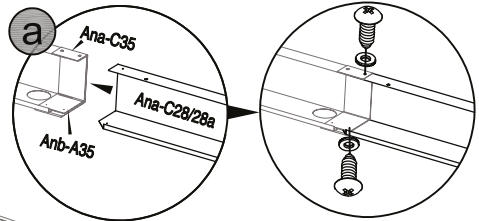
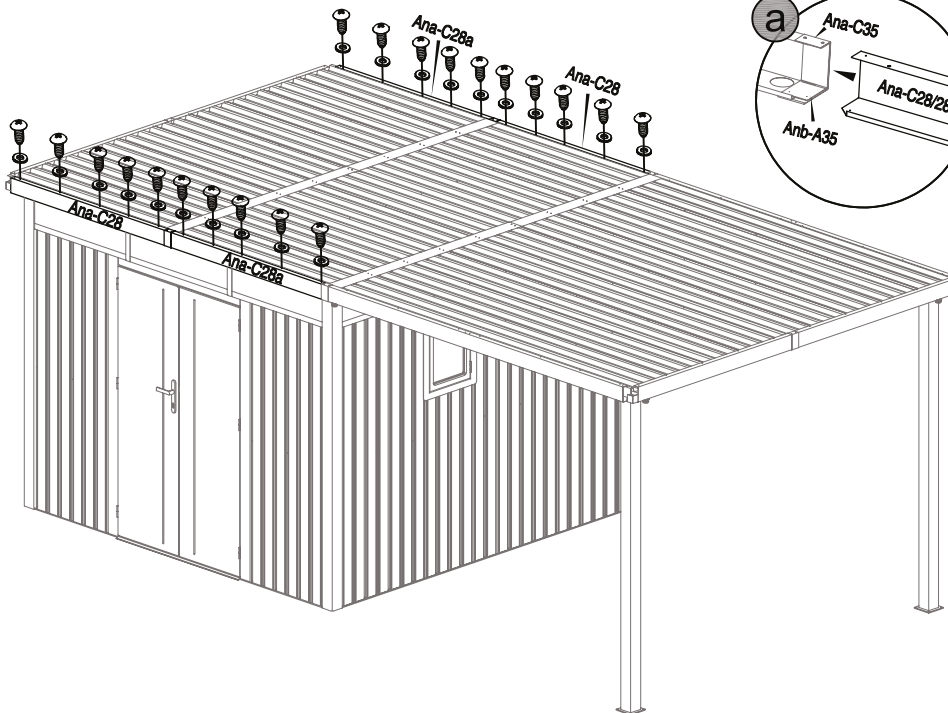

10



21



Ana-P2 [x4]



AnbX-D41 [x16]

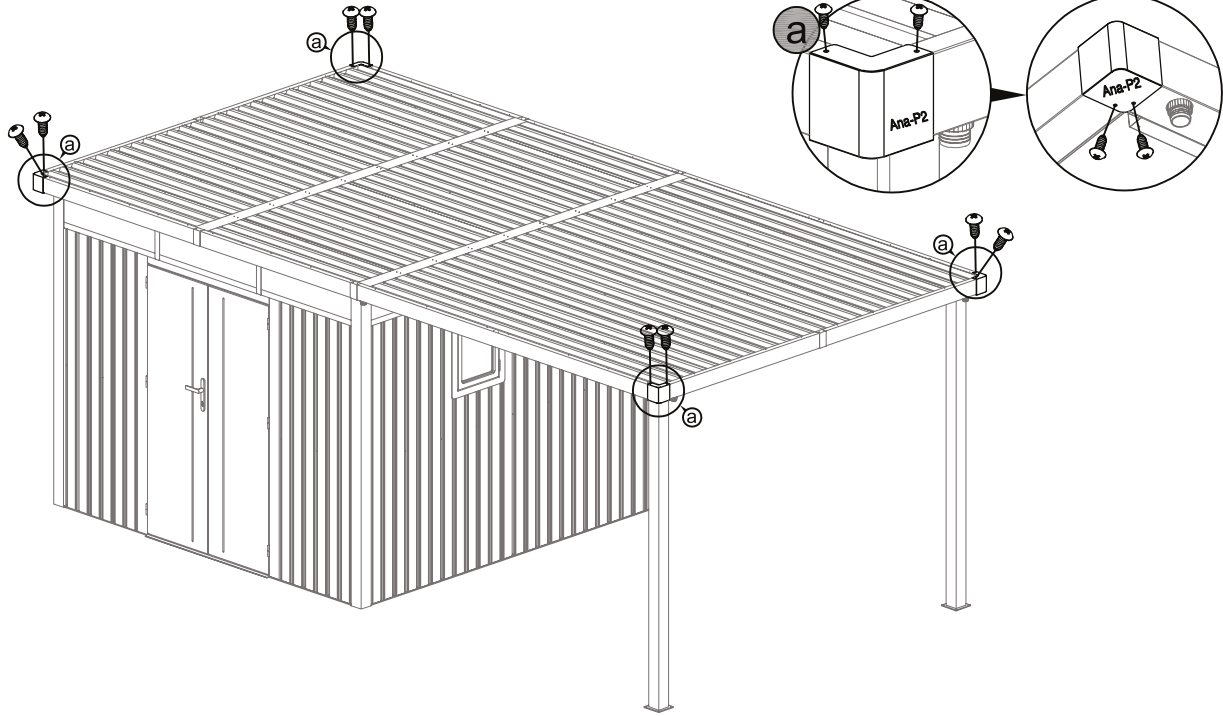

22



Anb-45 [x8]

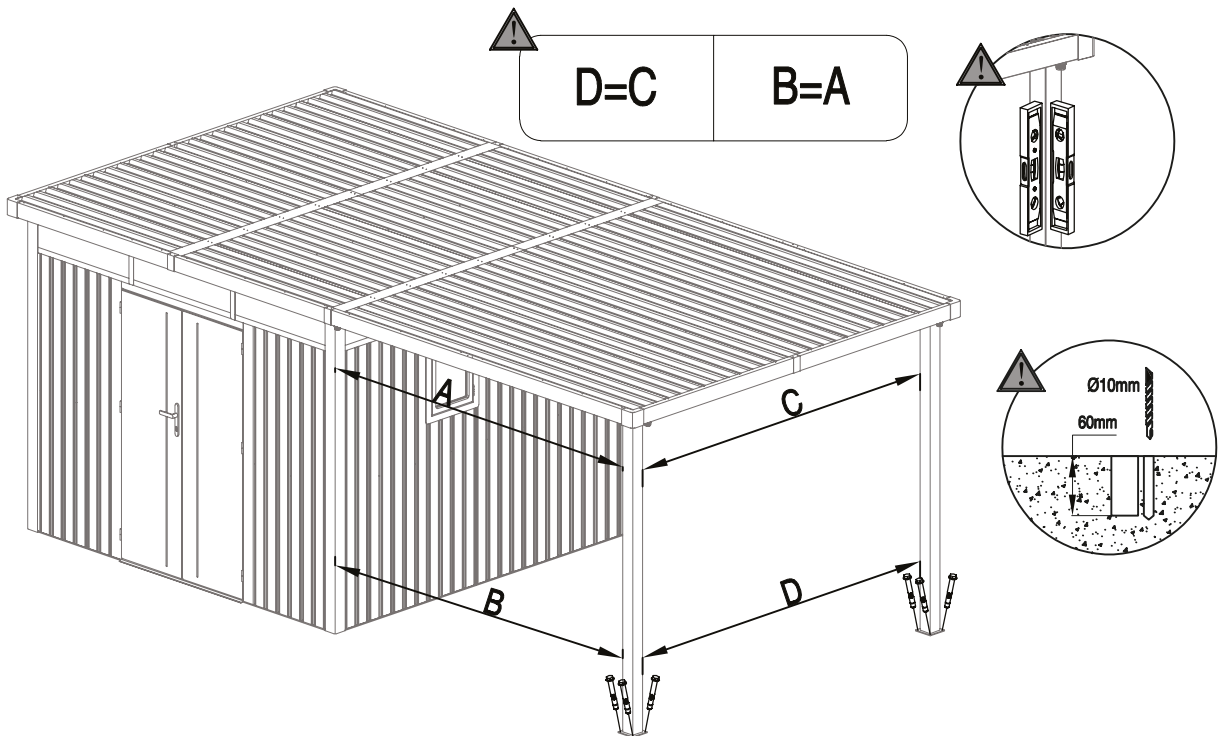

11





**Rainpipe assembly**



**Montage waterafvoer**



**Montage des Wasserablaufs**



**Montage du drain d'eau**



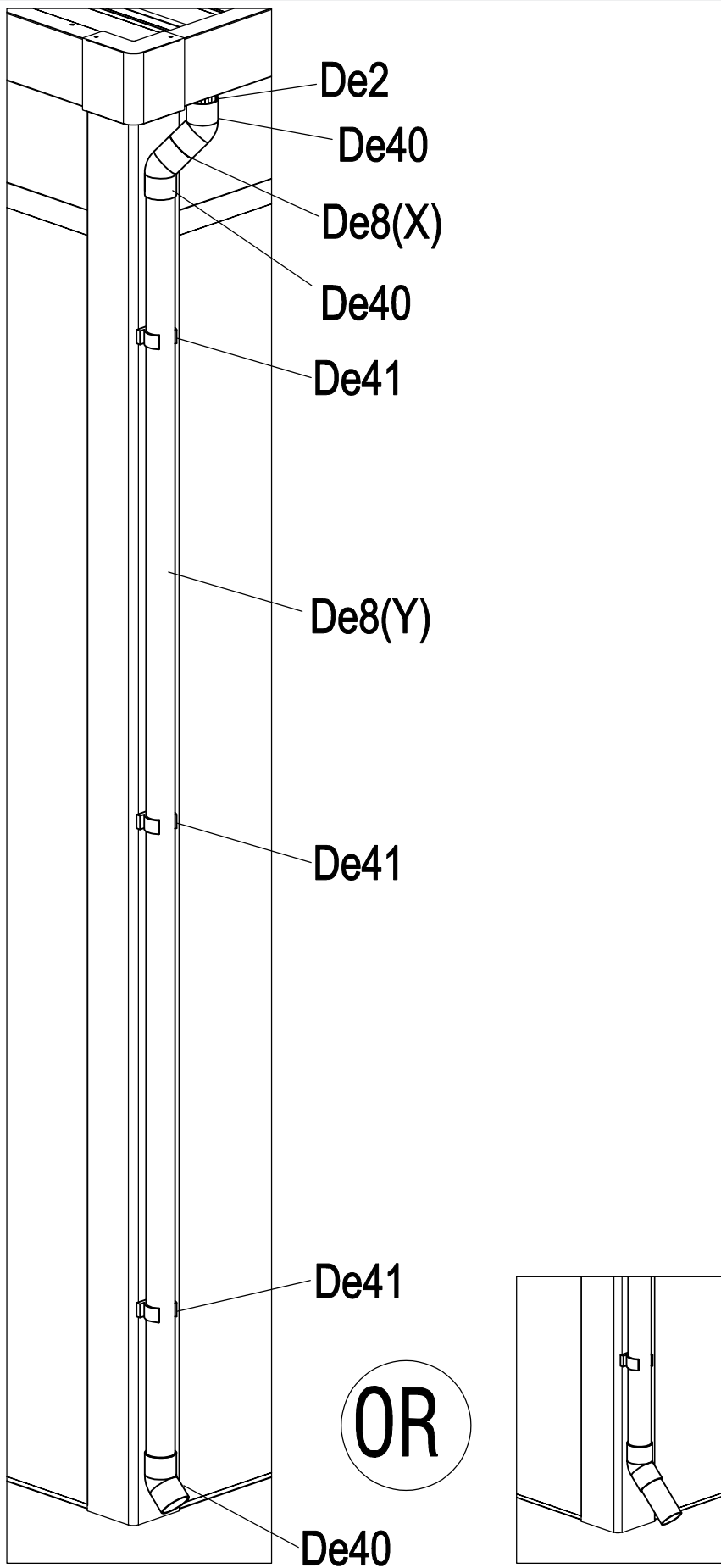

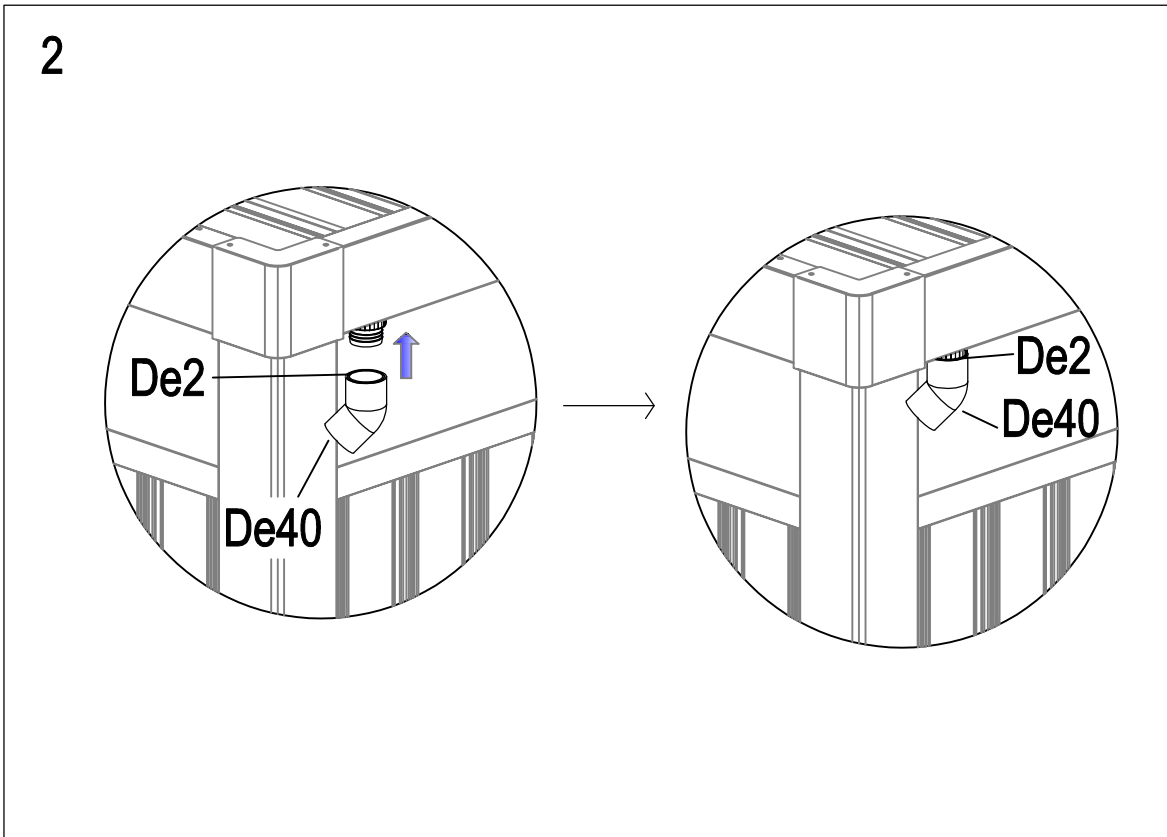
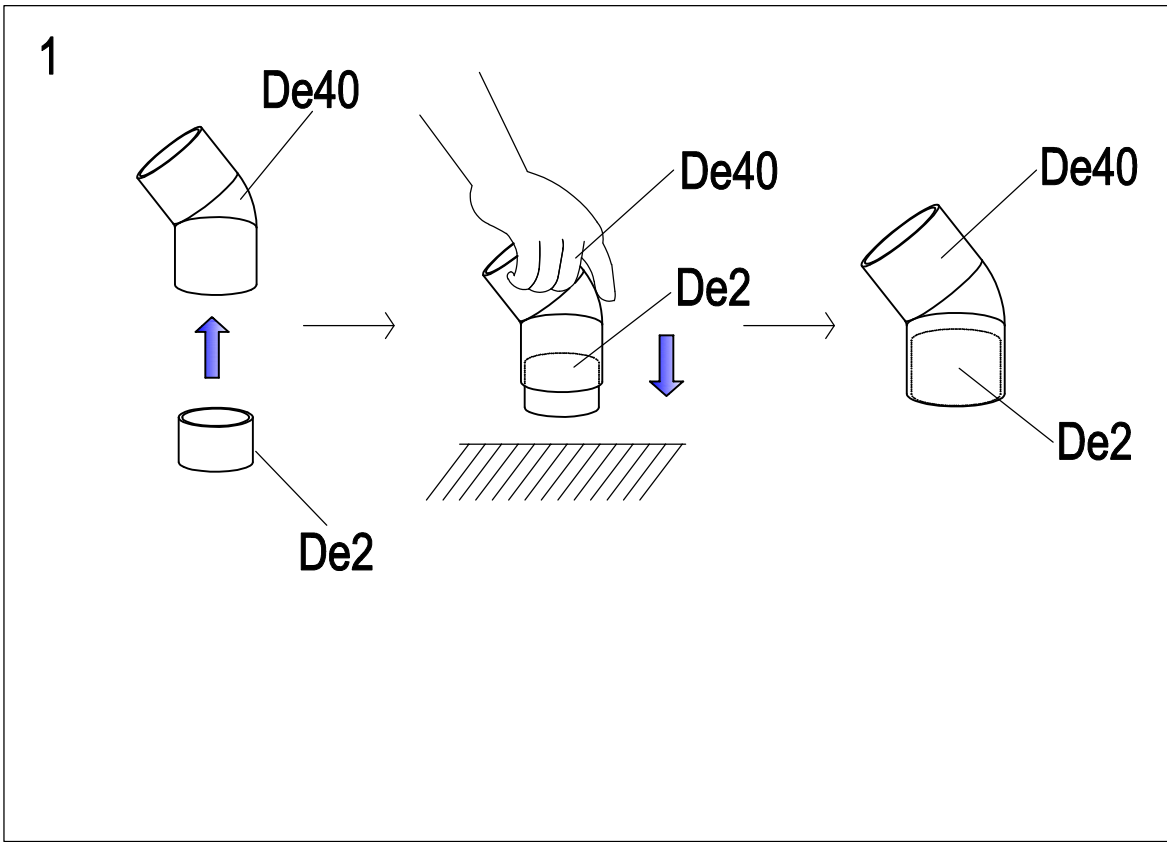

3

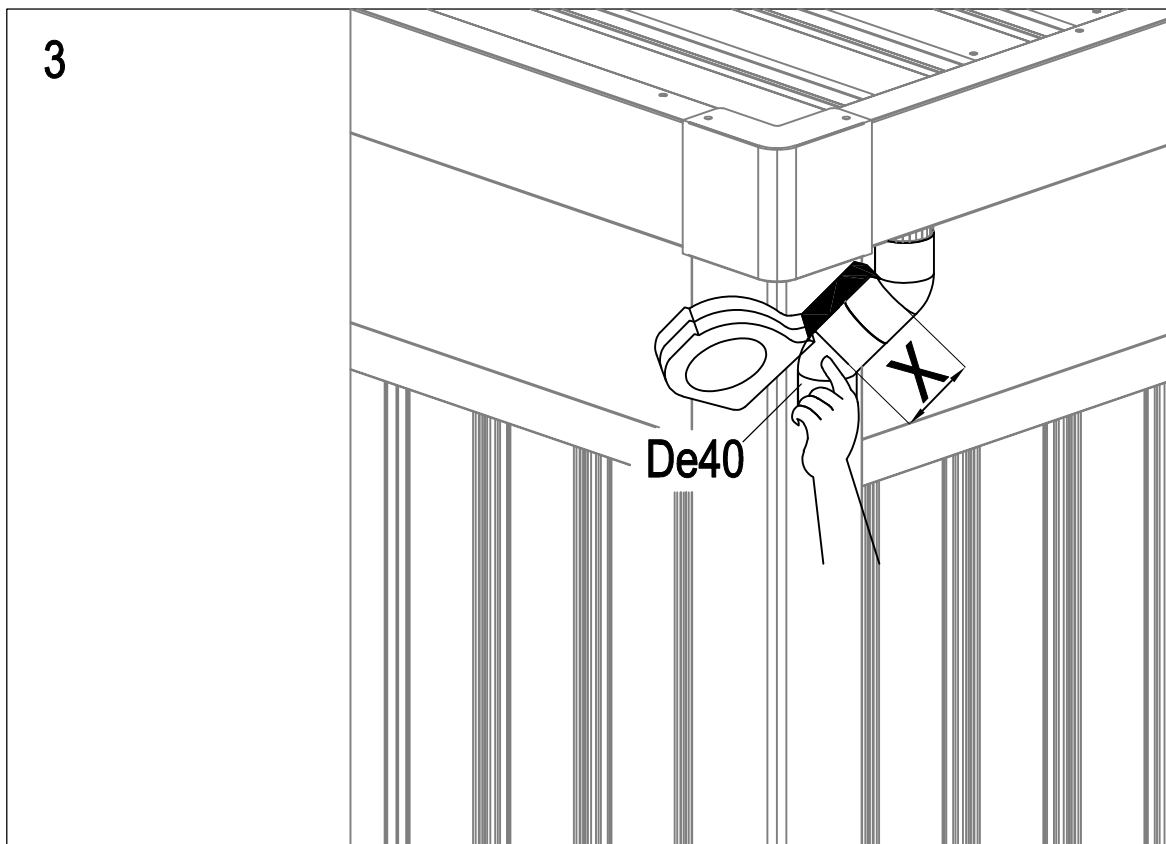

4

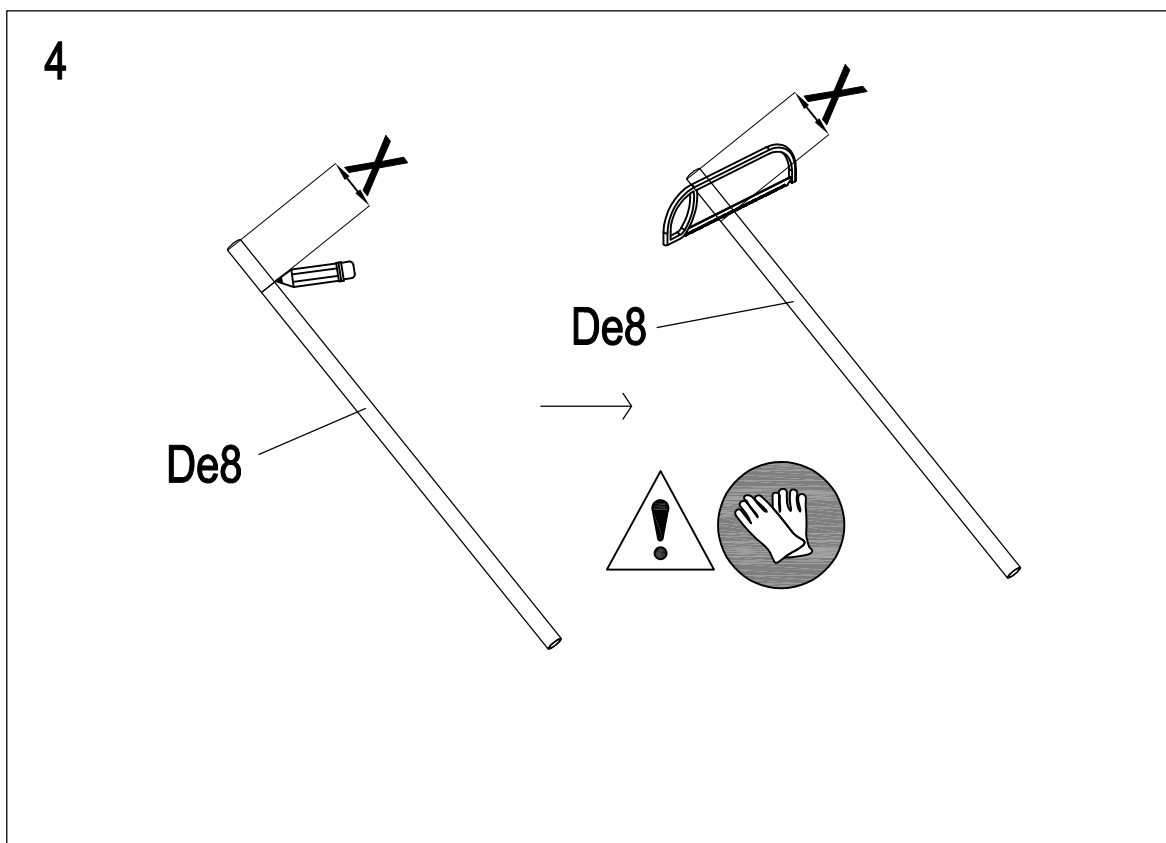

5

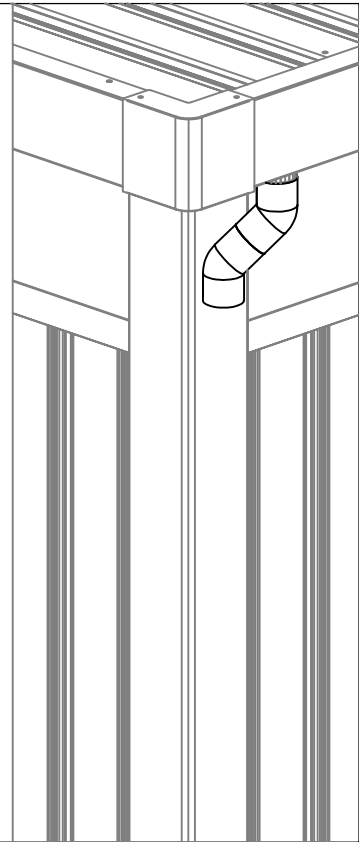
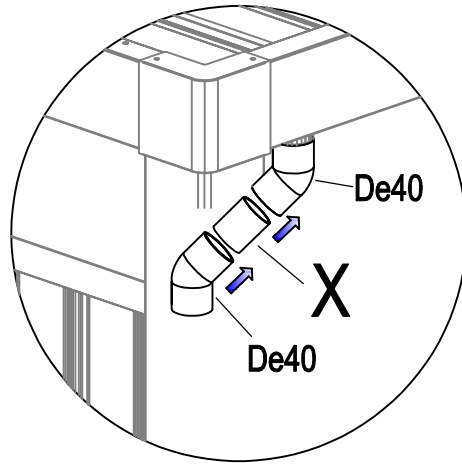

6

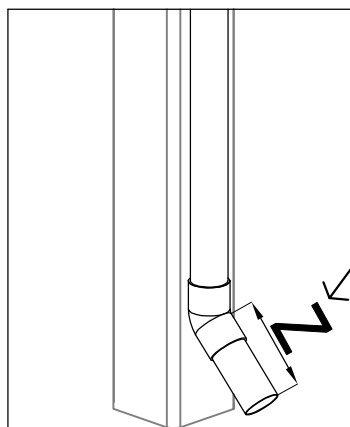

Measure  
the desired  
pipe length

OR

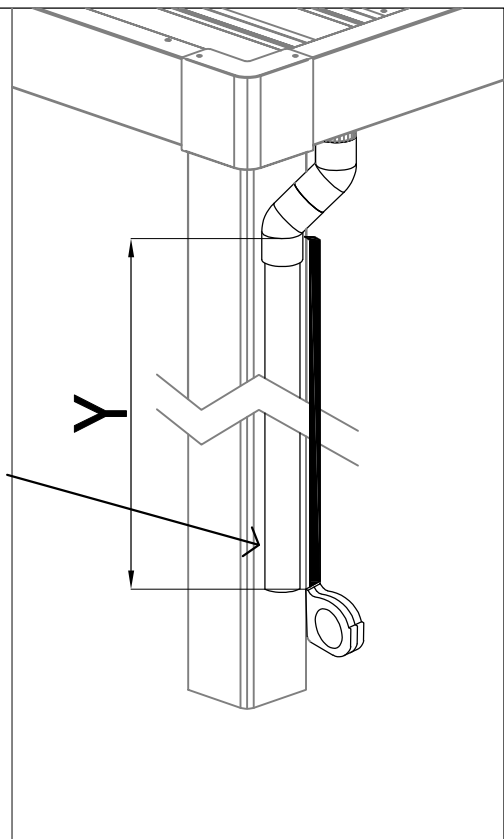

7

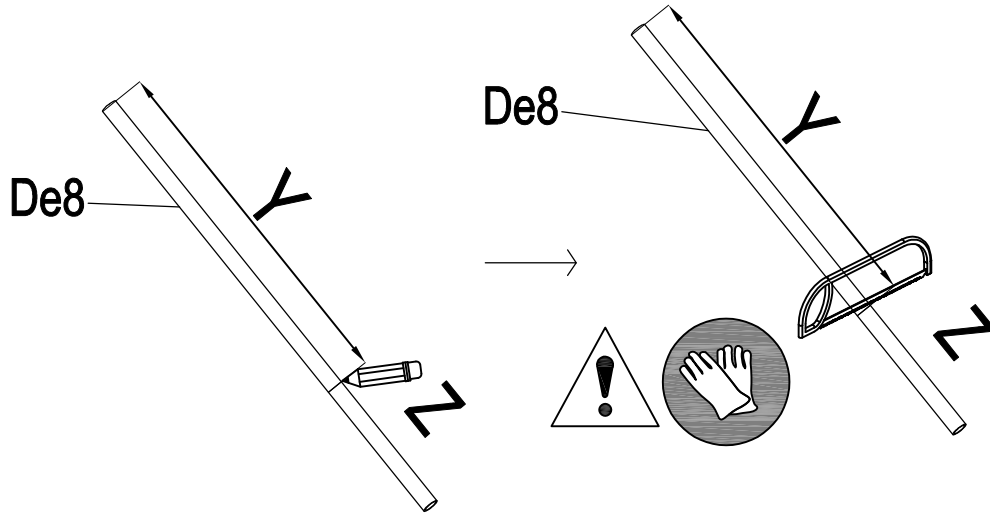

8

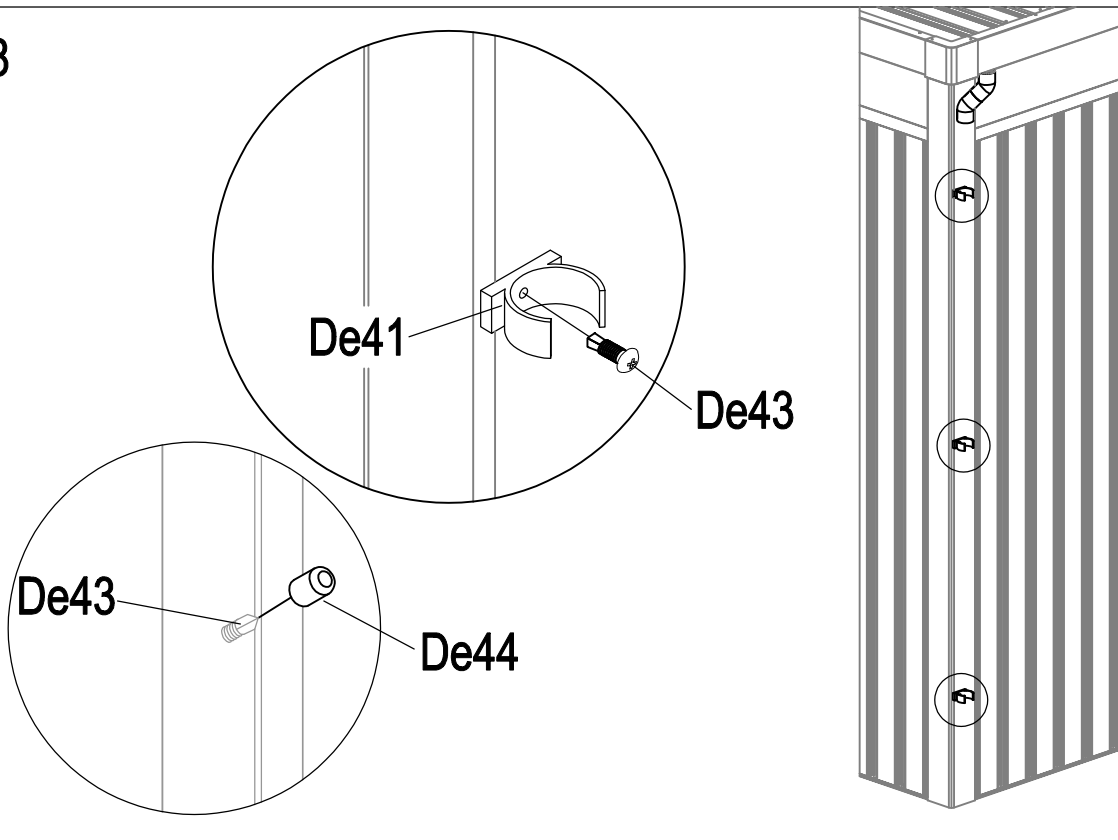

**EN:** Use a sealant for all surfaces that is also waterproof. (Not included)  
**NL:** Gebruik siliconenkit die toepasbaar is voor alle oppervlakten en waterdicht is.  
(Niet inbegrepen)  
**DE:** Verwenden Sie einen Silikondichtstoff geeignet für alle Oberflächen und wasserfest ist.  
(Nicht im Lieferumfang enthalten)  
**FR:** Utilisez un mastic silicone adapté à toutes les surfaces et également imperméable  
(non inclus).

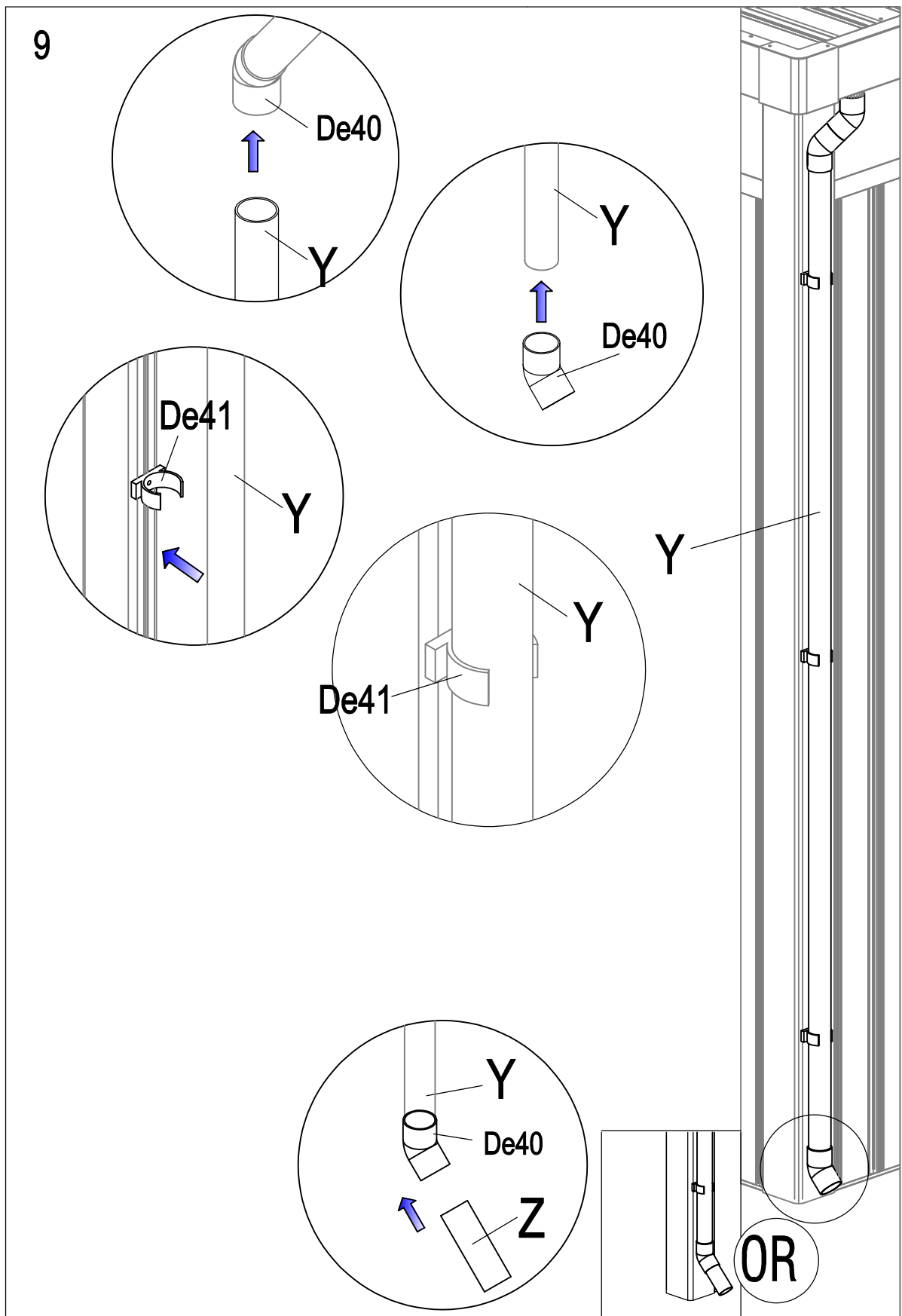



Garden & Storage

---

Witvrouwenbergweg 13B  
5711 CN, Someren  
Nederland